

EXECUTE

1/10 4WD MINI COMPETITION TOURING CAR

XM1

INSTRUCTION MANUAL

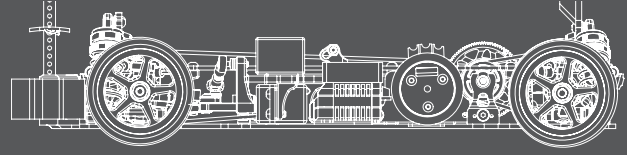

Bag A and Screw Bag



Titanium Turnbuckle M3 x 29mm
XP-40098



Titanium Turnbuckle M3 x 18mm
XP-40097



Titanium Turnbuckle M3 x 16mm
XP-40096

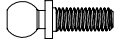

4.8mm Ball End 8mm Thread
XP-10150



4.8mm Ball End 6mm Thread
XP-10149



4.8mm Ball End 5mm Thread
XP-10148

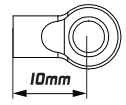
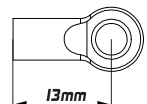
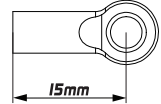

Low Profile Ball End Set
XP-10254



Stabilizer Connector
XP-10326



Hex Set Screw M3 x 8mm
XP-40054

2X

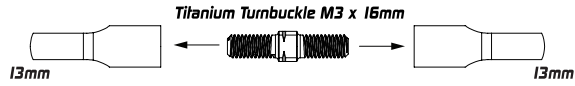

For Rear Camber Link

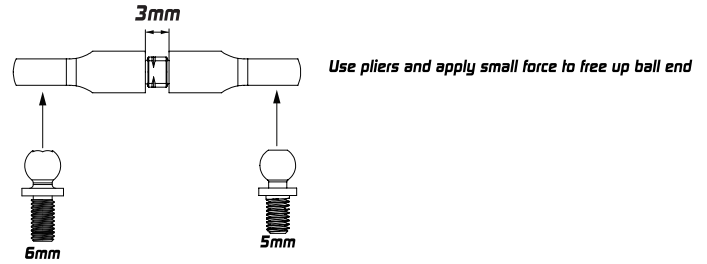

2X

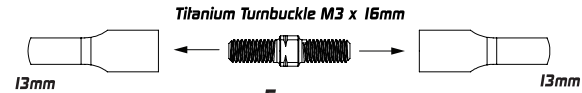

For Front Camber Link

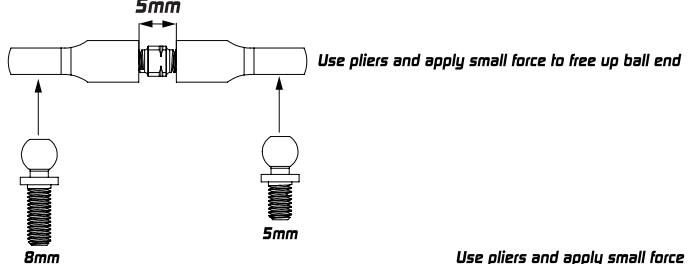

2X

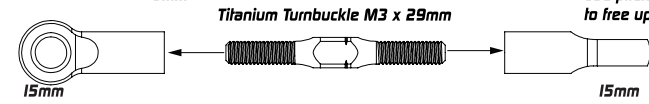

For Steering

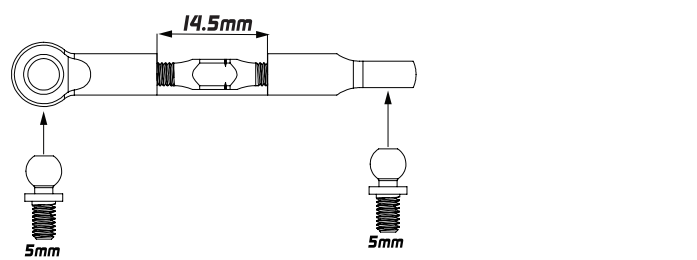

1X

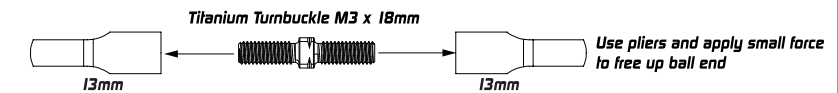

For Servo

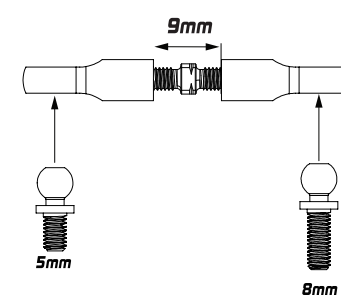

4X

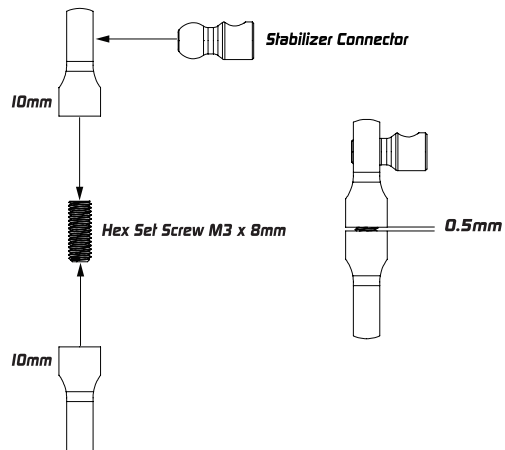

For Swaybar

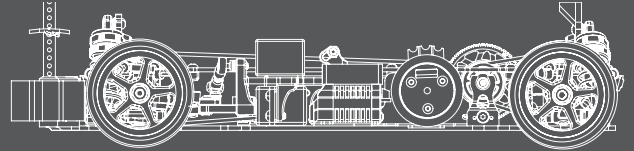

Bag B and Bearing Bag

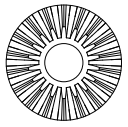

Bevel Gears 18T
XP-10009



Bevel Gears 10T
XP-10009

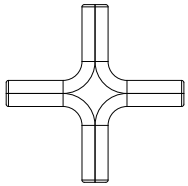

Gear Diff Cross Pin
XP-10009

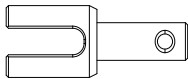

Alu Gear Diff Outdrive Adapter
XP-10125

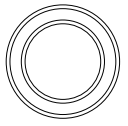

Bearing 10 x 15 x 4mm
XP-40065



O-ring 5 x 2mm
XP-10184



Pin 2 x 9.8mm
XP-40069

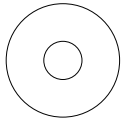

Spacer 5 x 15 x 0.4mm
XP-10181



Spacer 3.6 x 9.5 x 0.2mm
XP-10182



Flat Head Screw M2.5 x 10mm
XP-40044

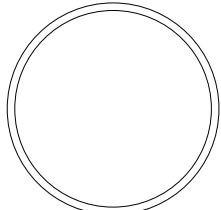

O-ring 25 x 1mm
XP-10183

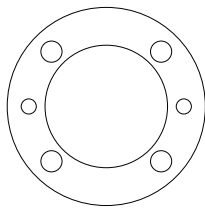

Diff Gasket
XP-10179

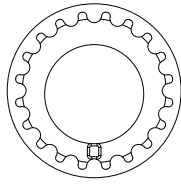

Composite Adjustment
Ball-Bearing Hub
XP-10107

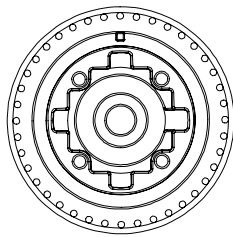

Gear Differential Case
XP-10008

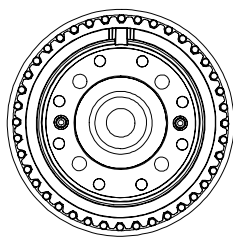

Gear Differential Cover
XP-10008

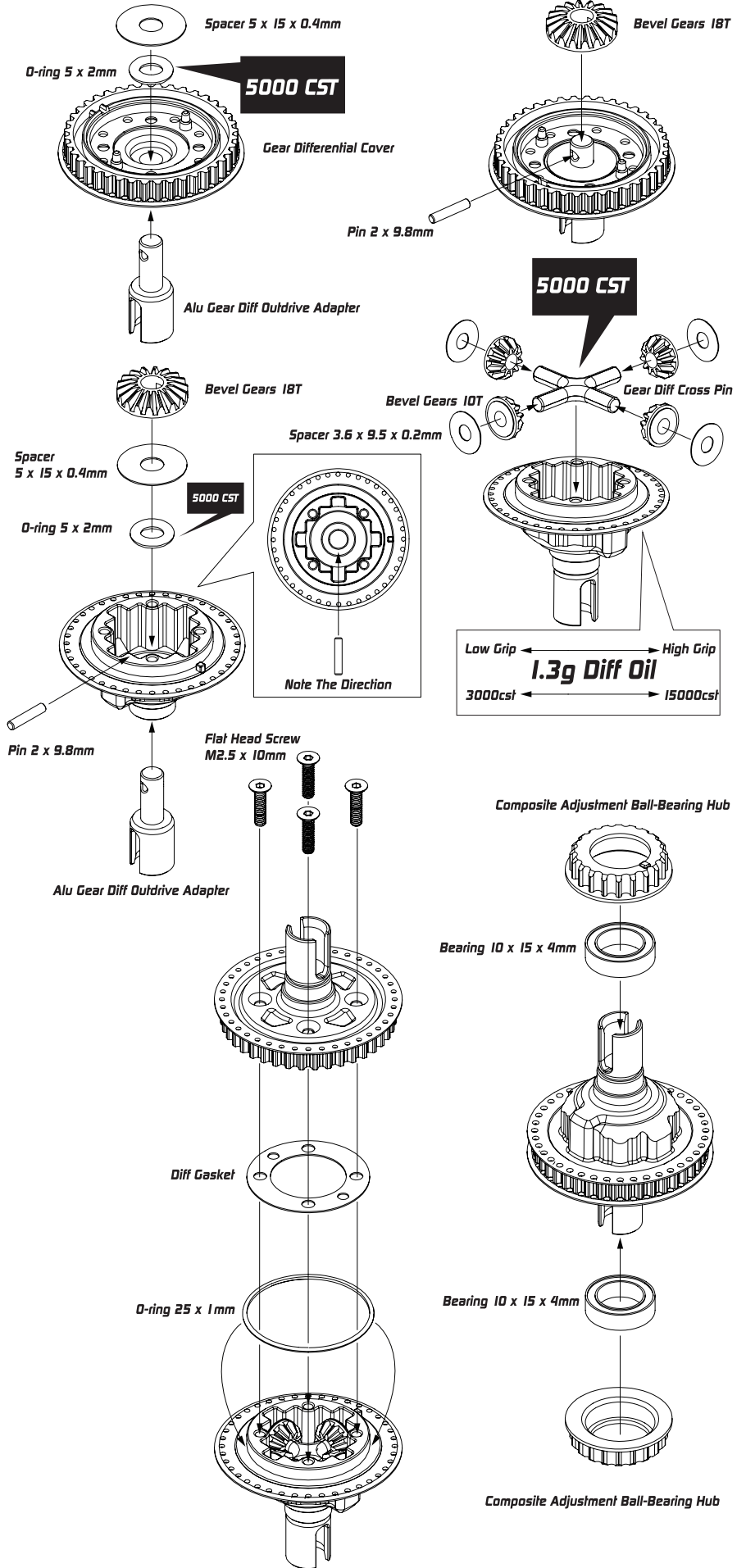

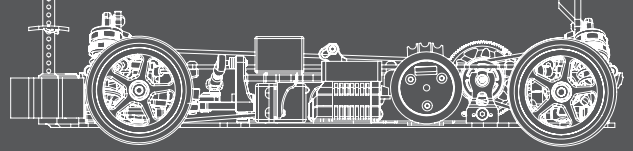

Bag C , Bearing and Screw Bag

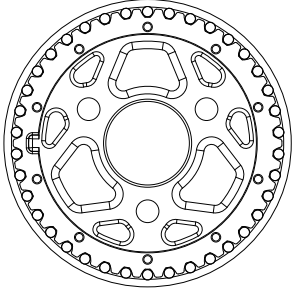

38T Pulley
XP-10134

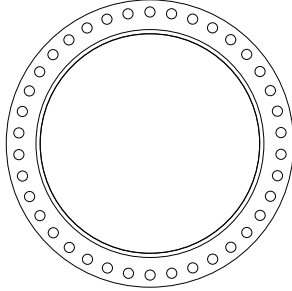

38T Pulley Cover
XP-10134

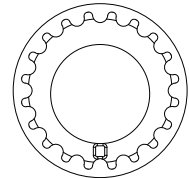

Composite Adjustment Ball-Bearing Hub
XP-10107

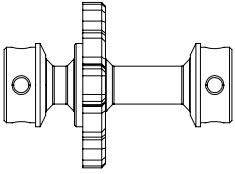

Alu Solid Spool
XP-10133

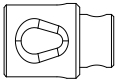

Axle Driveshaft Adapters
XP-10126



Pin 2 x 9.8mm
XP-40069

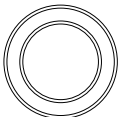

Bearing 10 x 15 x 4mm
XP-40065



Button Head Screw M3 x 6mm
XP-40037



Set Screw M3 x 3mm
XP-40052

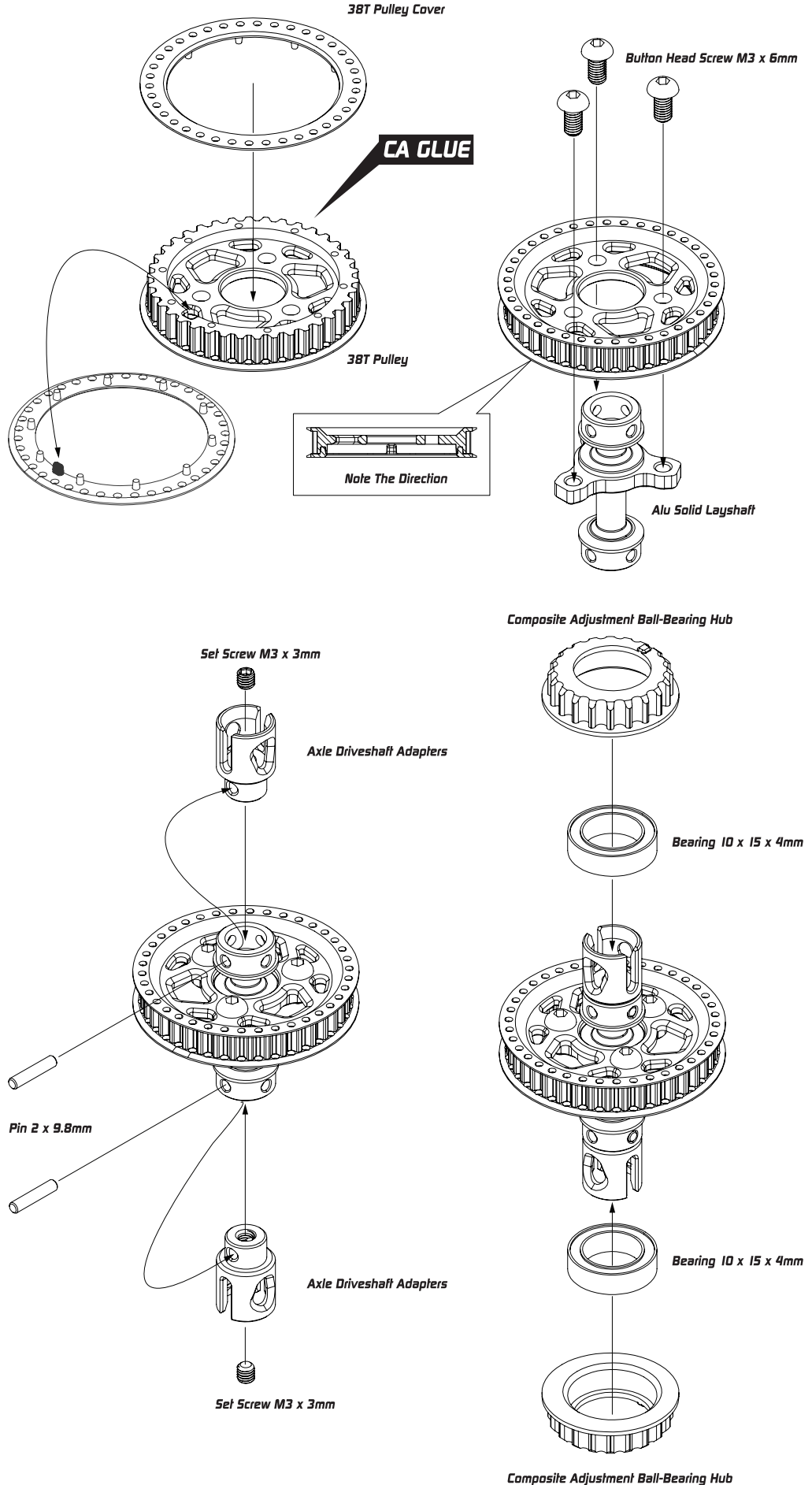

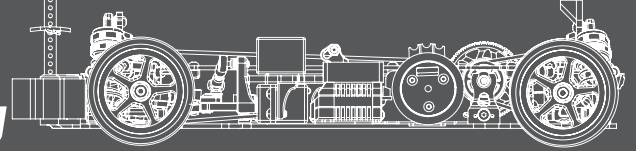

Bag D and Screw Bag

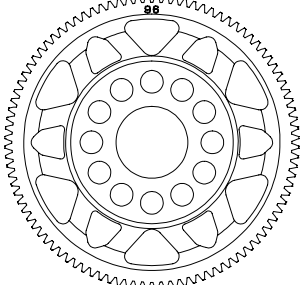

Spur Gear 64P 96T
XP-40082

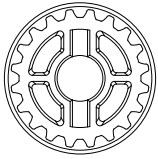

20T Center Pulley
XP-10134

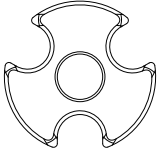

Center Pulley Cover
XP-10134

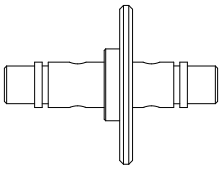

Alu Solid Layshaft
XP-10175



Button Head Screw M3 x 4mm
XP-40036



Pin 2 x 12mm
XP-40070



M5 E-Clip
XP-40058



Set Screw M3 x 3mm
XP-40052

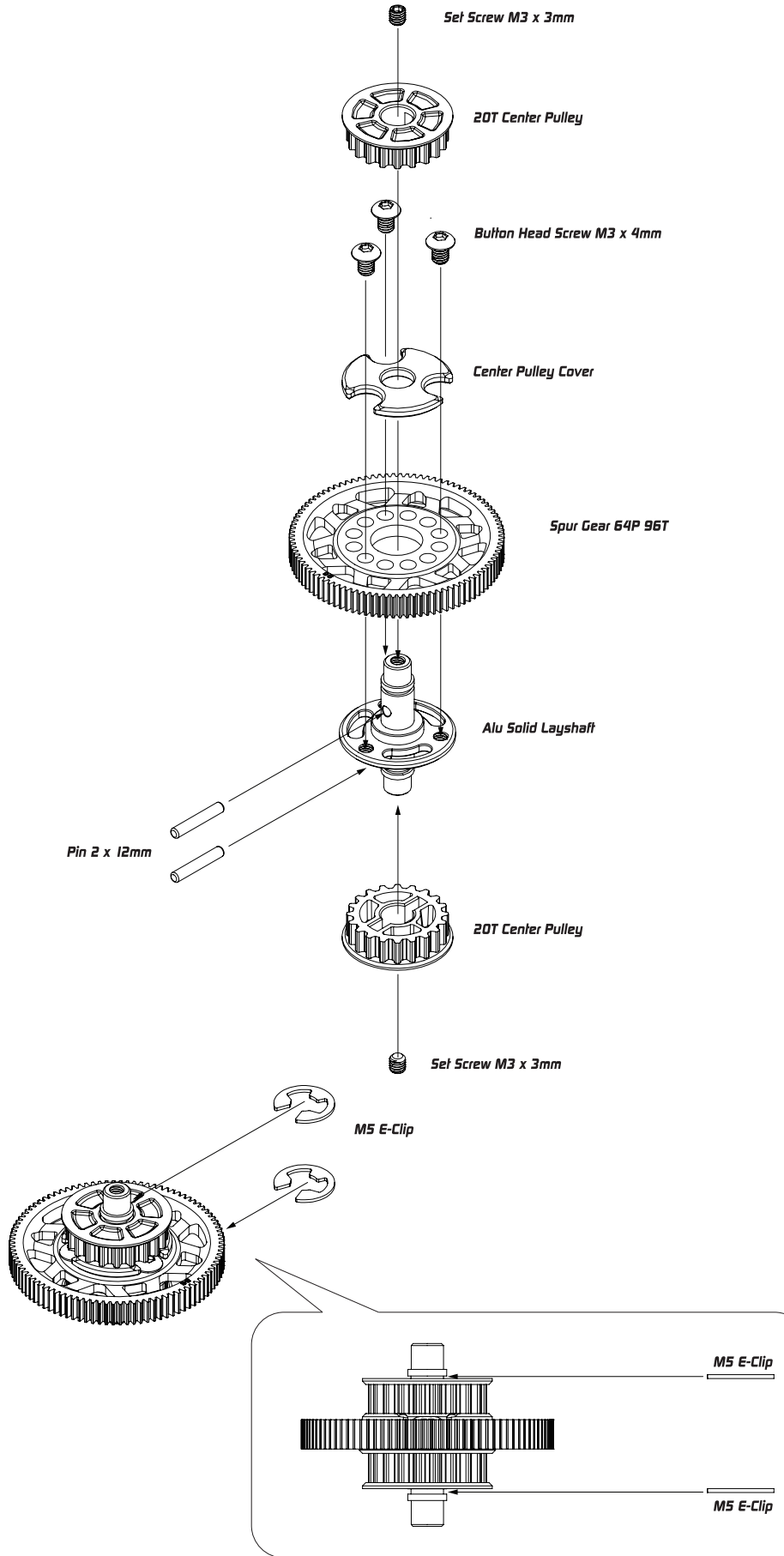

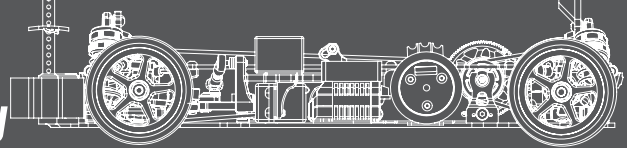

Bag E, Screw, Spacer and Bearing Bag

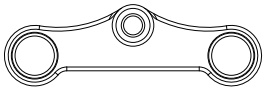

Alu Steering Plate For Dual Servo Saver 4mm
XP-10113

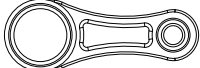

Alu Dual Servo Saver Arm
XP-10111



Bearing 5 x 8 x 2.5mm
XP-40061



Bearing 3 x 6 x 2.5mm
XP-40060



Alu Shim 3 x 6 x 1mm Red
XP-10119



Round Head Screw M3 x 8mm
XP-40038



Button Head Screw M3 x 6mm
XP-40037

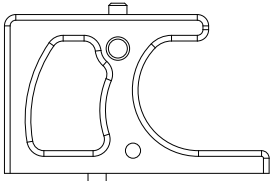

Alu Servo Mount
XP-10136

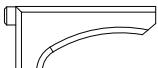

Alu Servo Side Mount
XP-10136



Servo Horn 23T for Sanwa, KO
XP-10163



Servo Horn 25T for Futaba
XP-10163

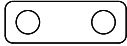

Servo Spacer
XP-10136

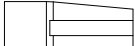

Antenna Holder
XP-10001



Flat Head Screw M3 x 10mm
XP-40049



Flat Head Screw M3 x 6mm
XP-40046



Battery Stopper
XP-10185



Graphite Floating Servo Holder 3.0mm
XP-10137

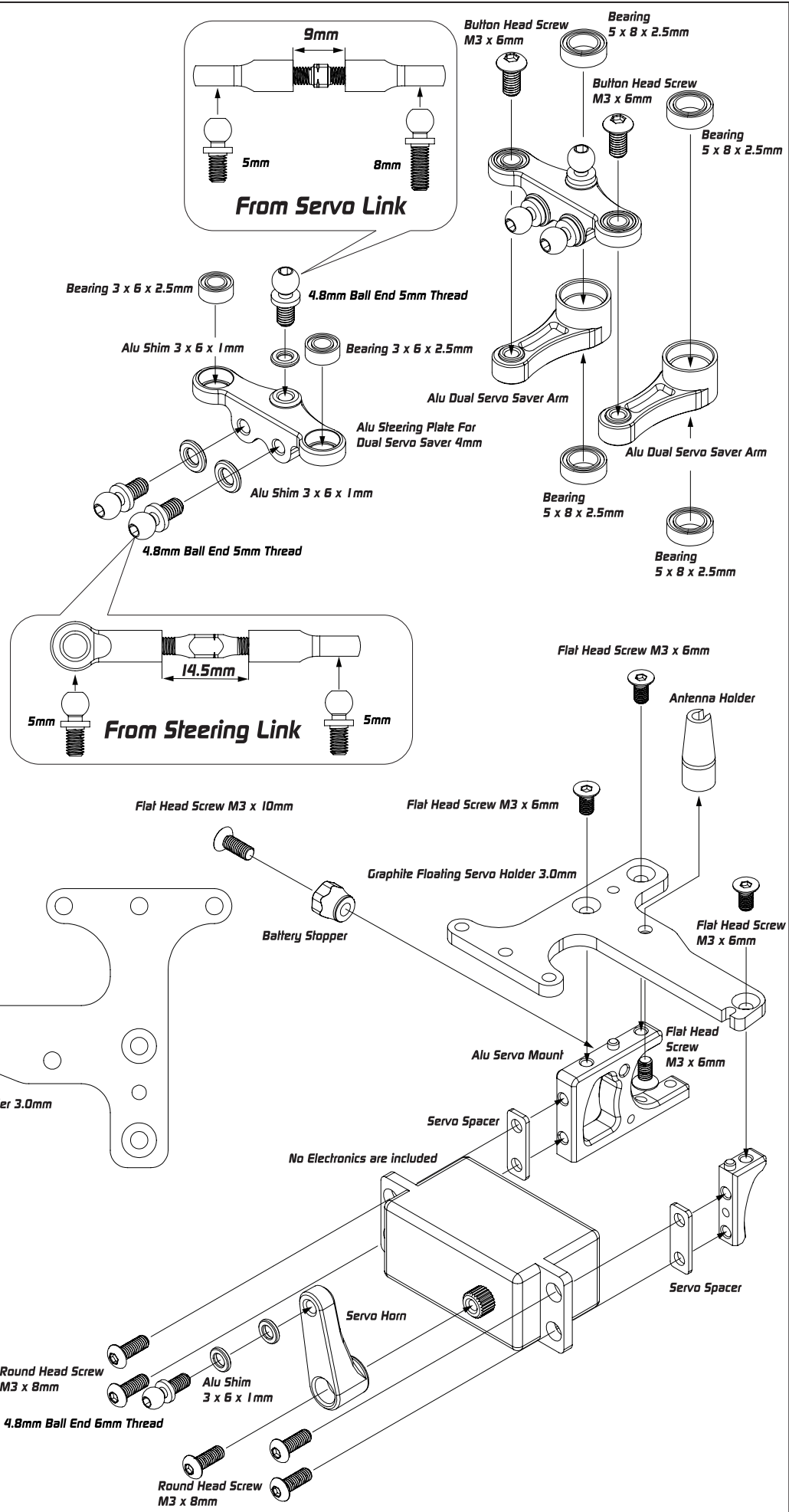

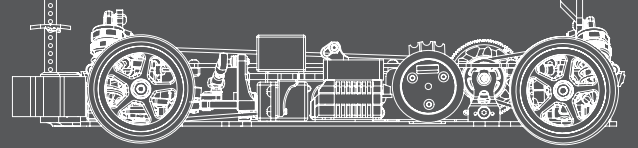

Bag F , Screw , Spacer and Bearing Bag

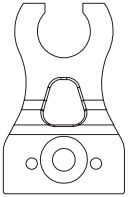

Alu Layshaft Bulkhead
XP-10274

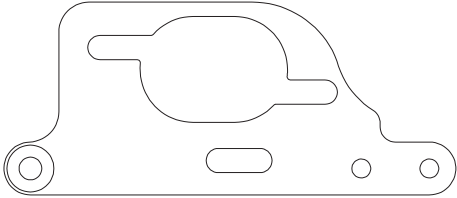

Alu Motor Mount Plate
XP-10232

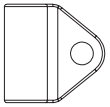

Alu Motor Mount Center Support
XP-10232



3 x 6 x 1 mm Composite Spacer
XP-10261



Aluminum Center Post
XP-10259



Bolt Head Screw M3 x 6mm
XP-40037



Flat Head Screw M3 x 12mm
XP-40050



Flat Head Screw M3 x 10mm
XP-40049



Flat Head Screw M3 x 6mm
XP-40046



Bearing 5 x 10 x 4mm
XP-40064

Alu Layshaft Bulkhead

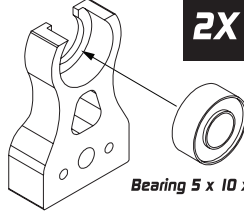

2X

Bearing 5 x 10 x 4mm

Aluminum Center Post



Alu Motor Mount Center Support

Alu Shim
3 x 6 x 1mm

Bolt Head Screw M3 x 6mm

Do not fully tighten screws, follow procedure as shown in next step

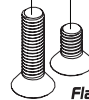

Flat Head Screw M3 x 12mm
Flat Head Screw M3 x 6mm

1

Flat Head Screw M3 x 6mm

2

Flat Head Screw M3 x 10mm

Alu Motor Mount Plate



3

4

Flat Head Screw M3 x 6mm

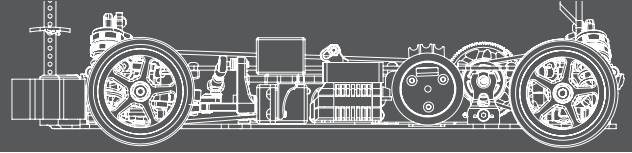

Bag G and Screw Bag

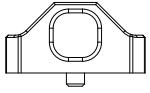

Alu Lower 2-Piece Suspension Holder
XP-10123

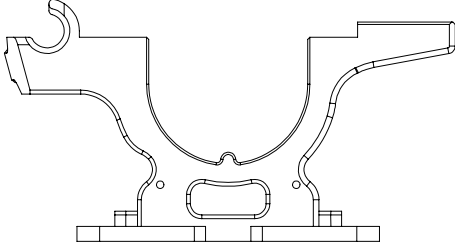

Alu Lower Bulkhead
XP-10115



Flat Head Screw M3 x 6mm
XP-40046

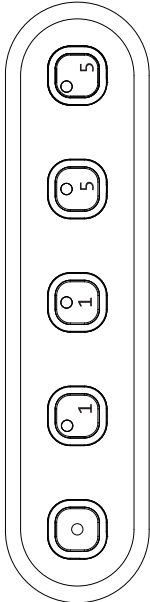

Eccentric Bushing Set
XP-10127

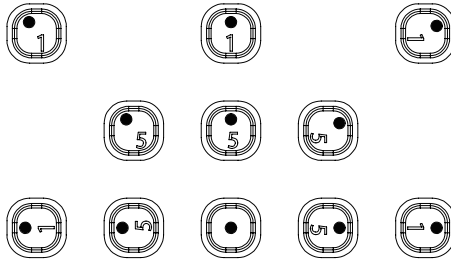

Diagonal Offset

Use either 0.5 or 1 mm to shift the roll center in a diagonal direction from the center.

4X

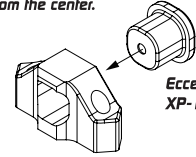

Eccentric Bushing Set
XP-10127

Alu Lower 2-Piece Suspension Holder XP-10123

Horizontal Offset

Choice of either 0.5 or 1 mm offset from center

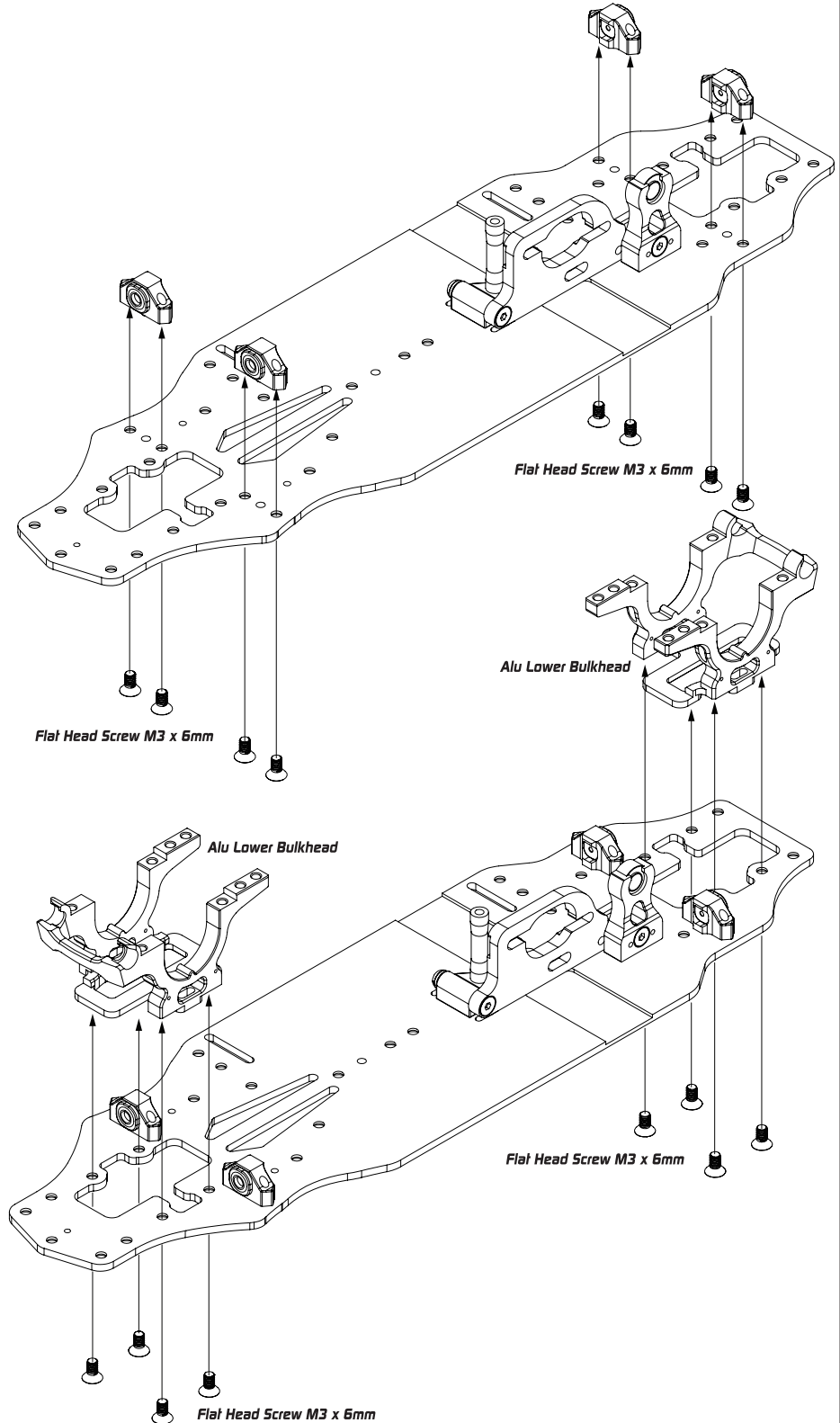

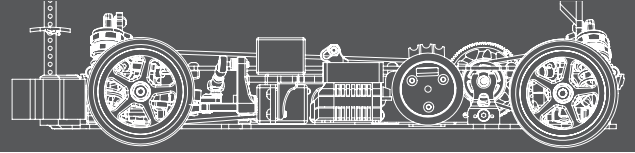

Bag G , Bag H , Screw , Bearing

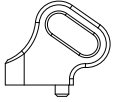

Bell Tensioner
XP-10163



Bearing 3 x 6 x 2.5mm
XP-40060



Spacer 3 x 5 x 0.2mm
XP-40066



Round Head Screw M3 x 16mm
XP-40041



Button Head Screw M3 x 6mm
XP-40037



Flat Head Screw M3 x 8mm
XP-40048



Flat Head Screw M3 x 6mm
XP-40046



Nut 3 x 5.5mm
XP-40067

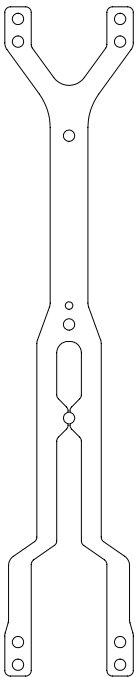

Graphite 2.0mm High Flex Upper Deck
XP-10355

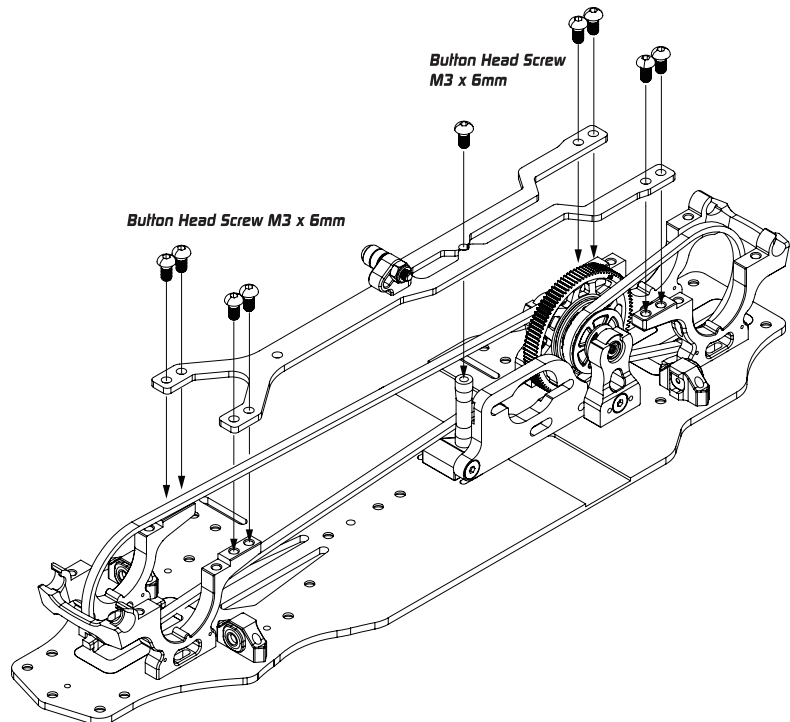
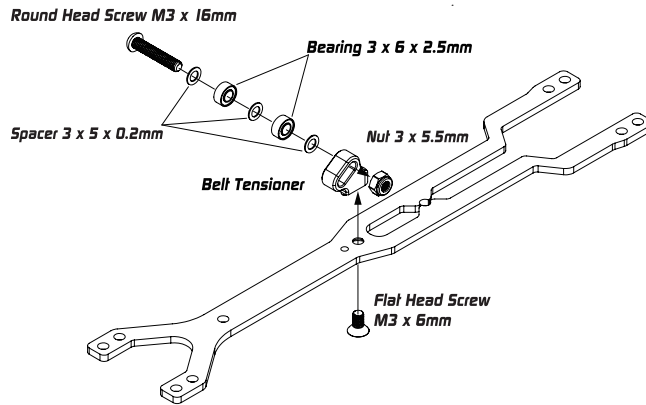
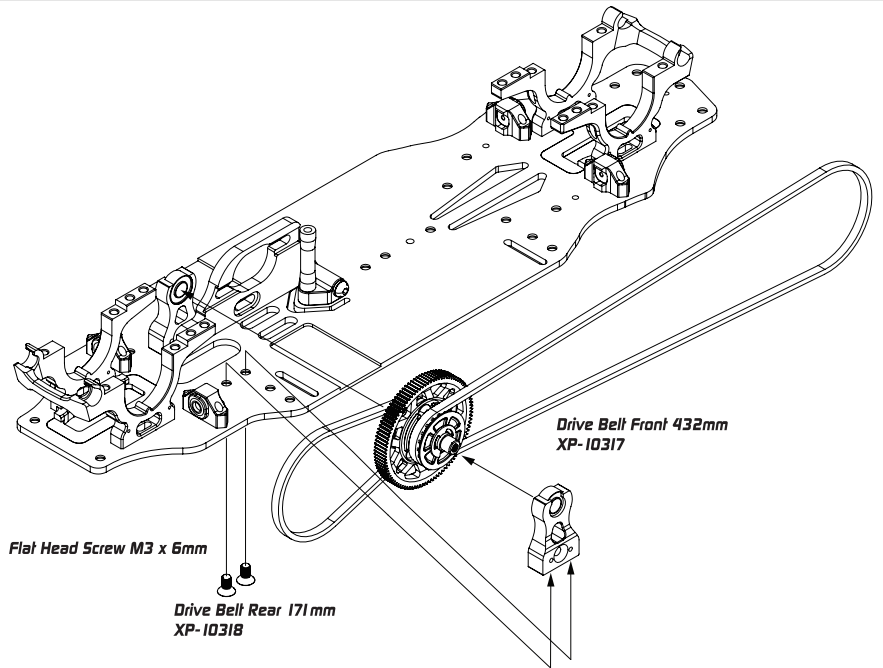

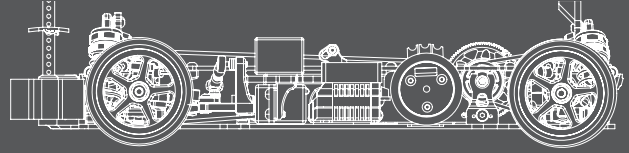

Bag 1 and Screw Bag

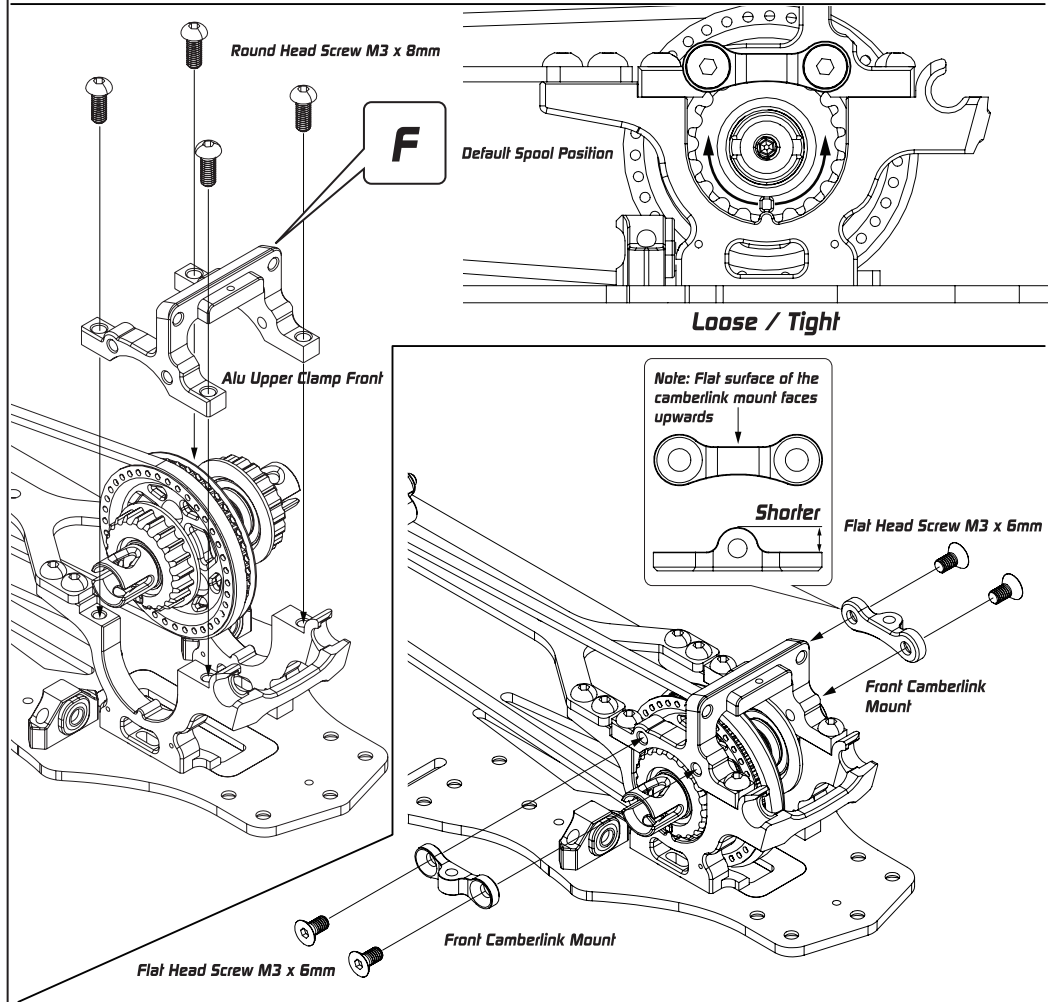
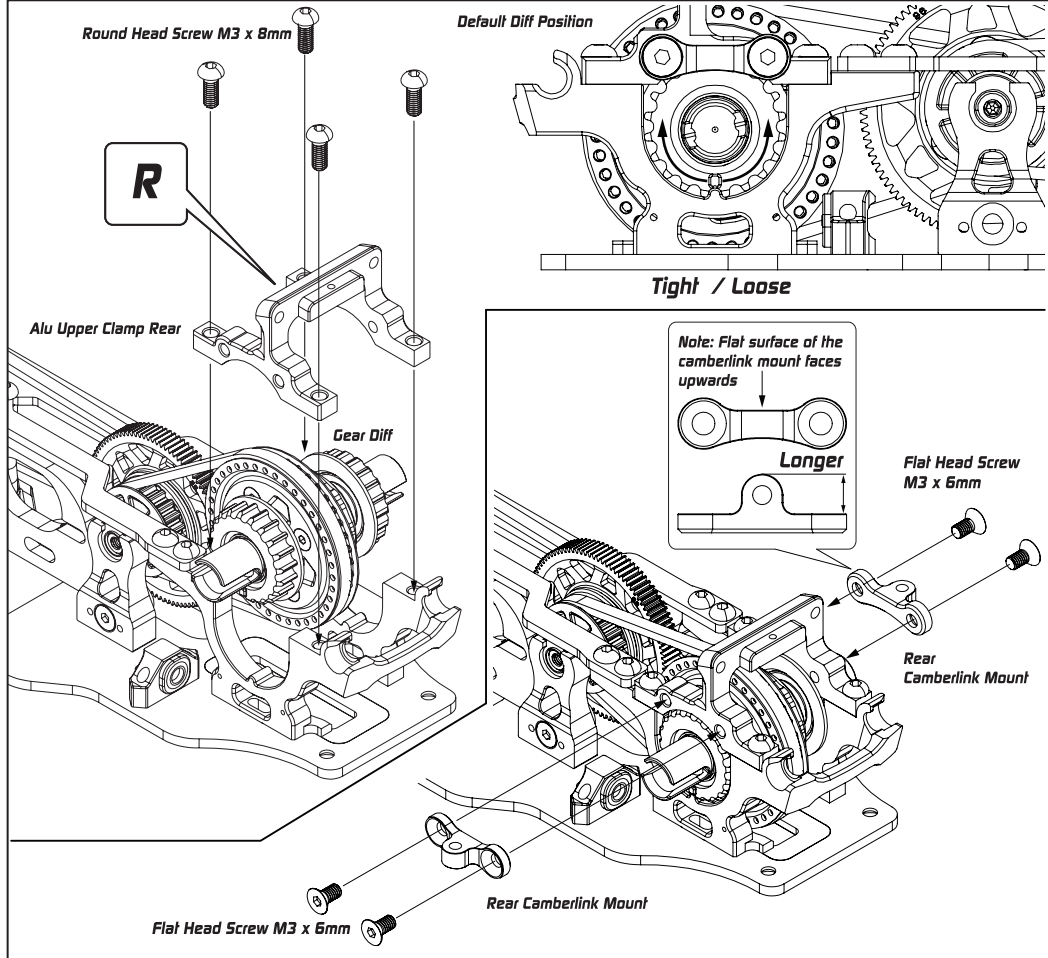
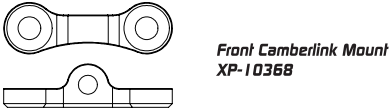
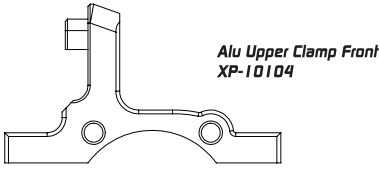
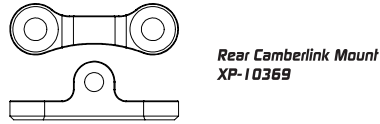
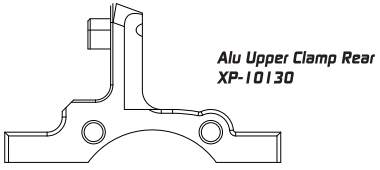

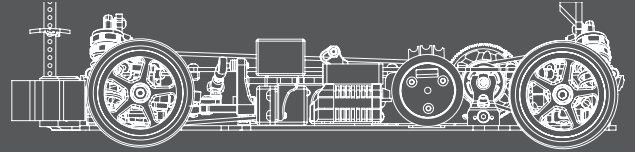

Screw Bag

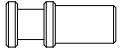

Aluminium Steering Post For Dual Servo Saver
XP-10112



Flat Head Screw M3 x 6mm
XP-40046



Button Head Screw M3 x 6mm
XP-40037

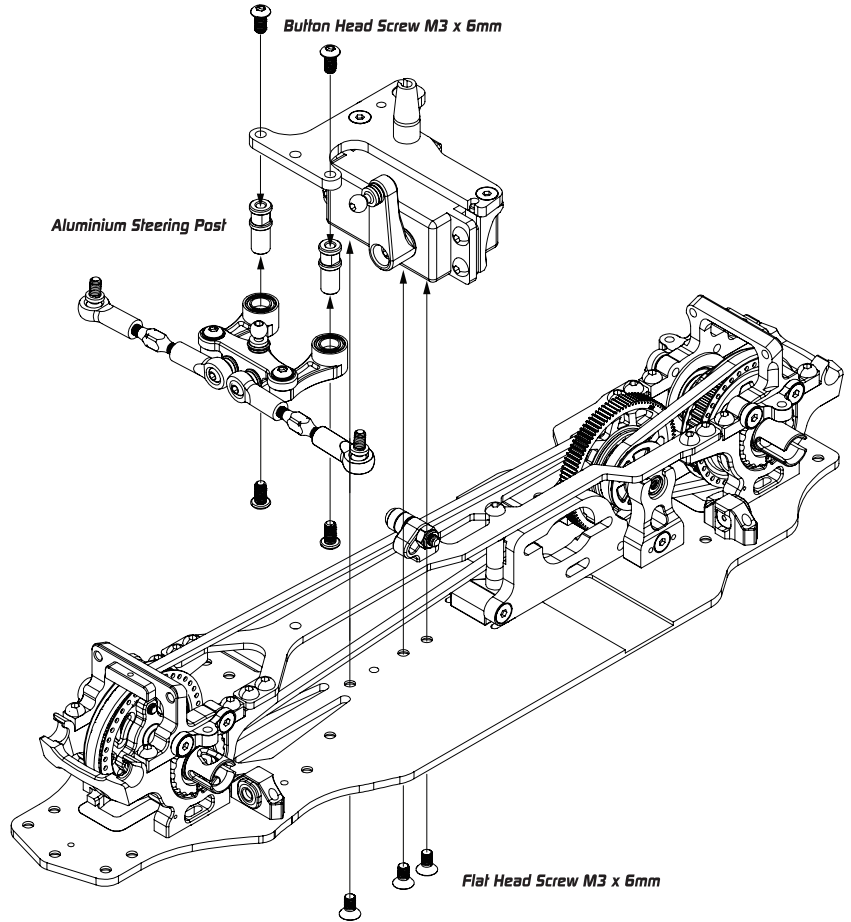

Non-Floating Steering (Optional)

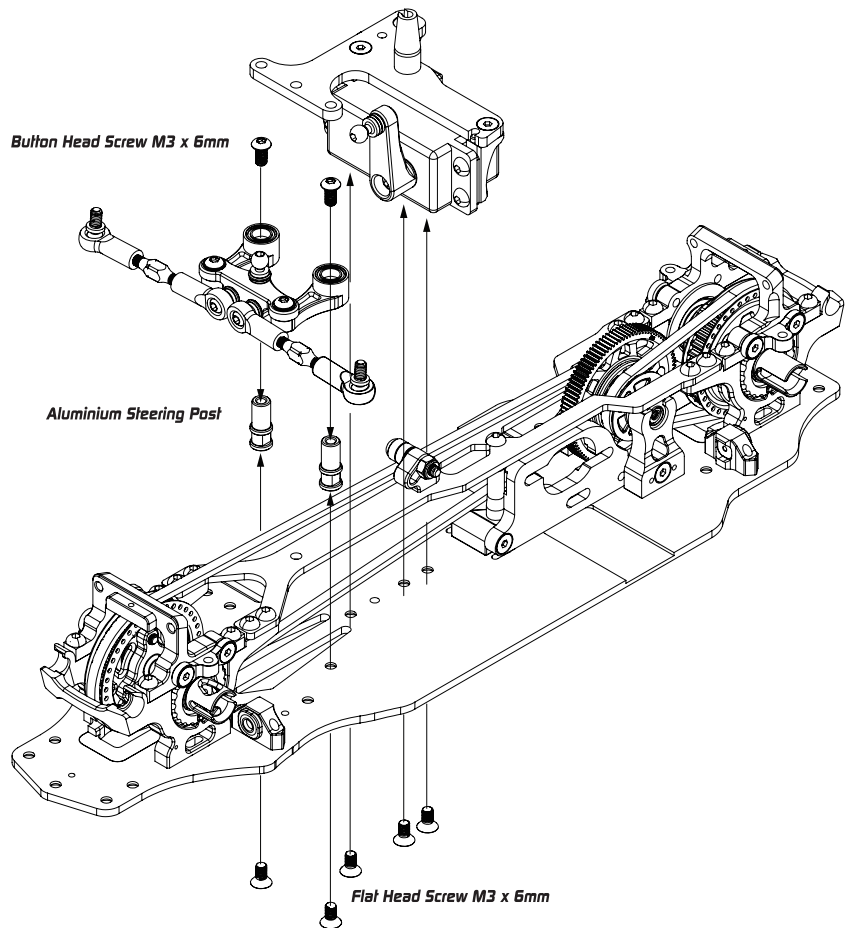

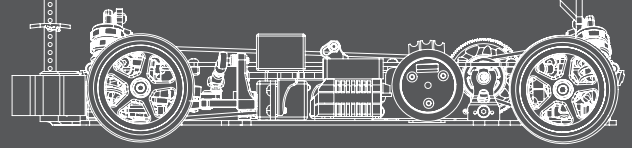

Bag J , Bearing and Screw Bag

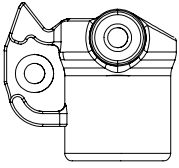

Composite Steering Block Right
XP-10277

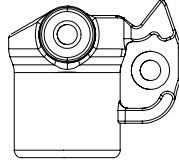

Composite Steering Block Left
XP-10277

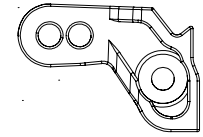

Composite Steering Block Plate Right
XP-10277

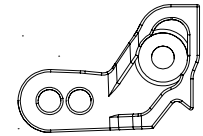

Composite Steering Block Plate Left
XP-10277

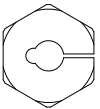

Alu Wheel Hub
XP-10129

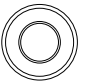

Bearing 5 x 10 x 4mm
XP-40064



Pin 2 x 9.8mm
XP-40069



Round Head Screw M3 x 8mm
XP-40038

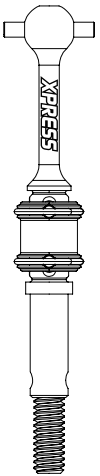

Double Joint Universal Shaft 2pcs
XP-10375



Cap Head Screw M1.6 x 4mm
XP-10129

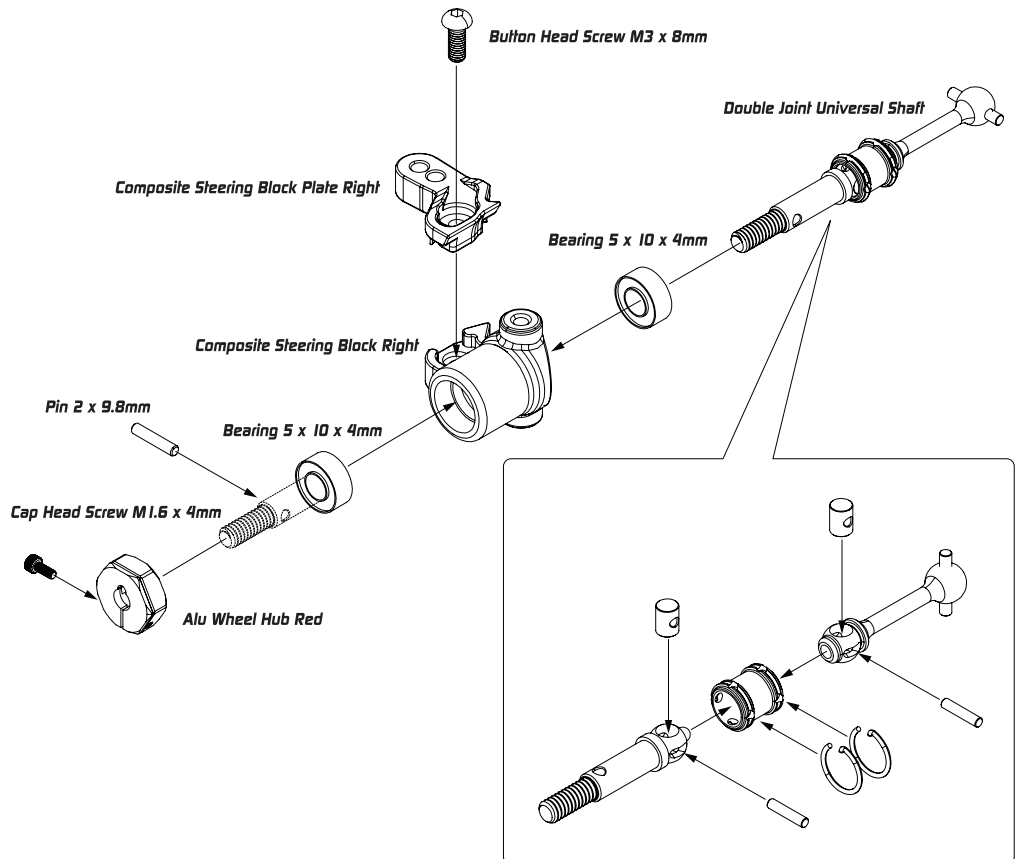
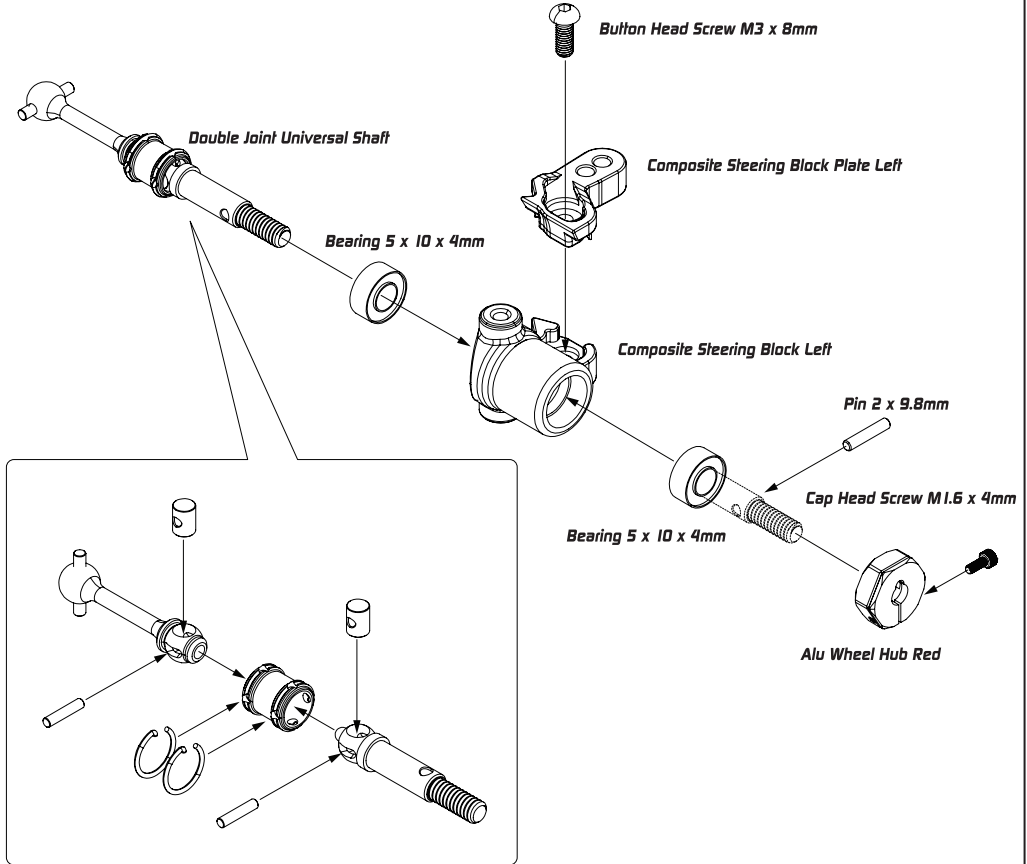

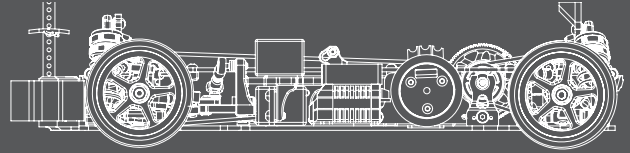

Bag J , Spacer and Screw Bag

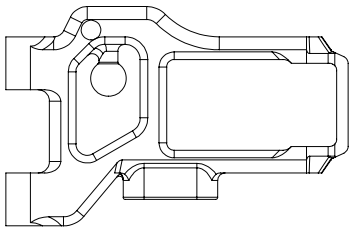

Composite Suspension Arm Front
XP-10276

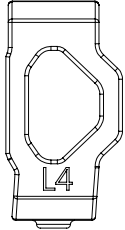

Composite C-Hub - 4° deg Left
XP-10278

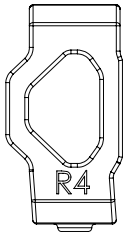

Composite C-Hub - 4° deg Right
XP-10278



Suspension Pivot Pin 3 x 42mm
XP-10139



3x18mm C Hub Upright Flat Type Pivot Pin
XP-10337



Set Screw M3 x 3mm
XP-40052



Hex Set Screw M3 x 8mm
XP-40054



Alu Shim 3 x 6 x 1mm
XP-10119



Alu Shim 3 x 6 x 2mm
XP-10120

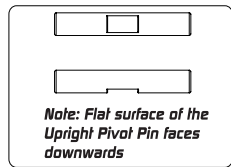

3x18mm C Hub Upright Flat Type Pivot Pin

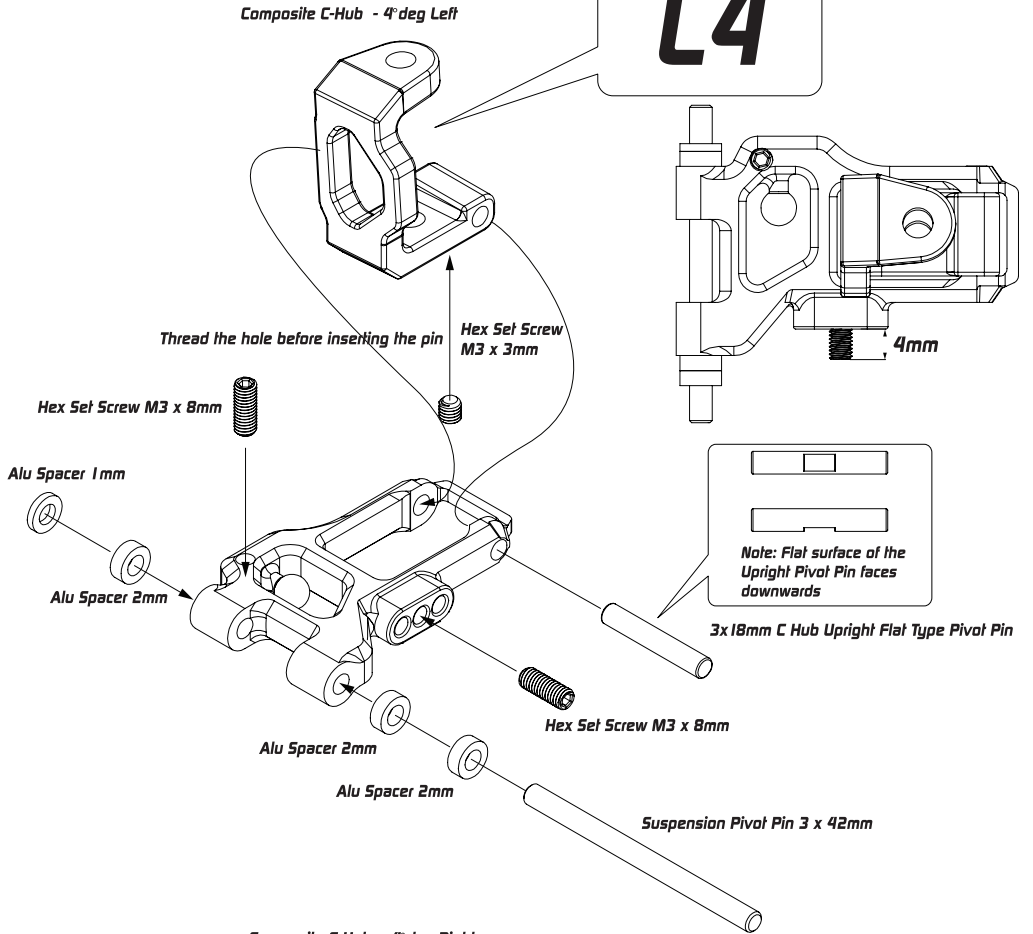

Composite C-Hub - 4° deg Left

L4

Thread the hole before inserting the pin

Hex Set Screw M3 x 3mm

Hex Set Screw M3 x 8mm

Alu Spacer 1mm

Alu Spacer 2mm

Hex Set Screw M3 x 8mm

Alu Spacer 2mm

Alu Spacer 2mm

Suspension Pivot Pin 3 x 42mm

Note: Flat surface of the Upright Pivot Pin faces downwards

3x18mm C Hub Upright Flat Type Pivot Pin

Composite C-Hub - 4° deg Right

R4

Thread the hole before inserting the pin

Hex Set Screw M3 x 3mm

Hex Set Screw M3 x 8mm

Alu Spacer 1mm

Alu Spacer 2mm

Hex Set Screw M3 x 8mm

Alu Spacer 2mm

Alu Spacer 2mm

Suspension Pivot Pin 3 x 42mm

4mm

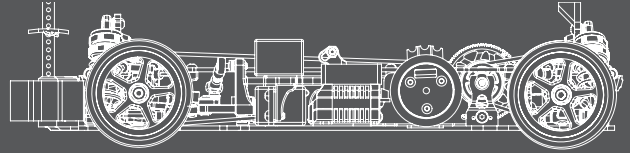

Bag J

  King Pin Collar
XP-10164

 King Pin
XP-10164

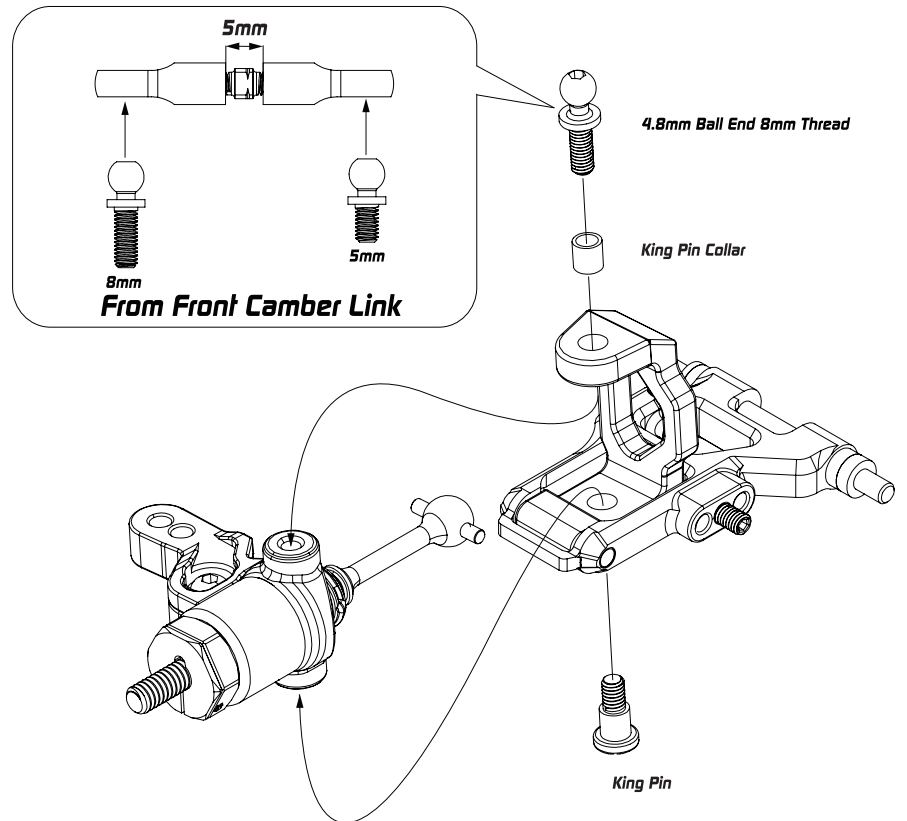
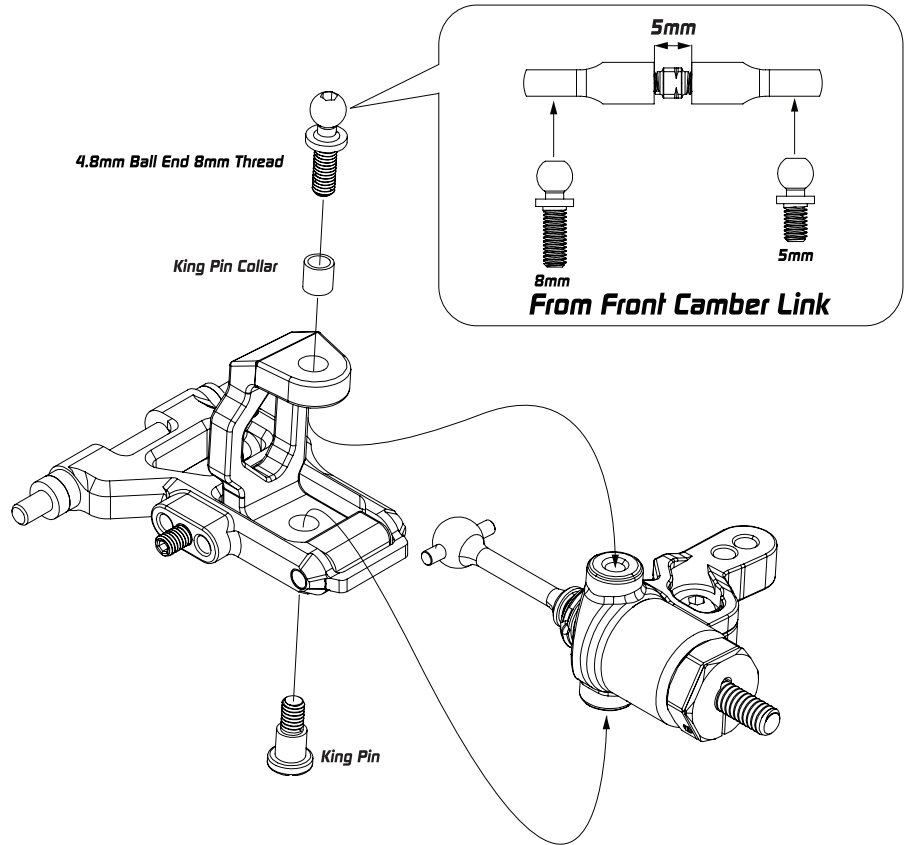

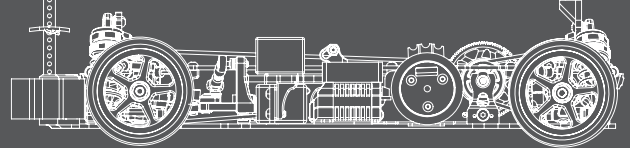

Bag J and Screw Bag

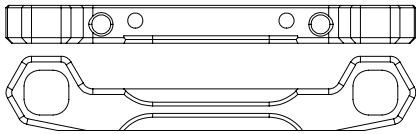

Alu Front Lower I-Piece Suspension Holder - FF
XP-10114



Flat Head Screw M3 x 6mm
XP-40046

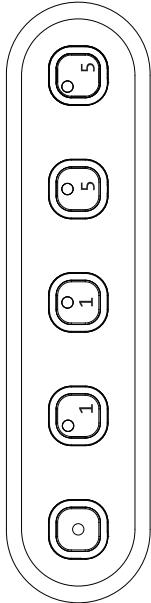

Eccentric Bushing Set
XP-10127

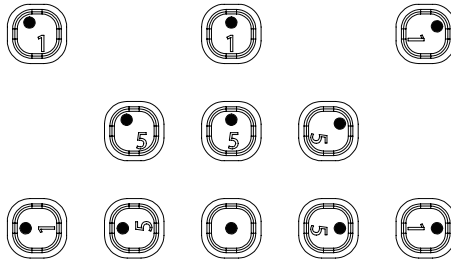

Default Setup

Diagonal Offset
Use either 0.5 or 1 mm to shift the roll center in a diagonal direction from the center.

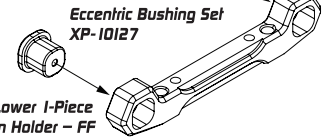

Eccentric Bushing Set
XP-10127

Horizontal Offset
Choice of either 0.5 or 1 mm offset from center

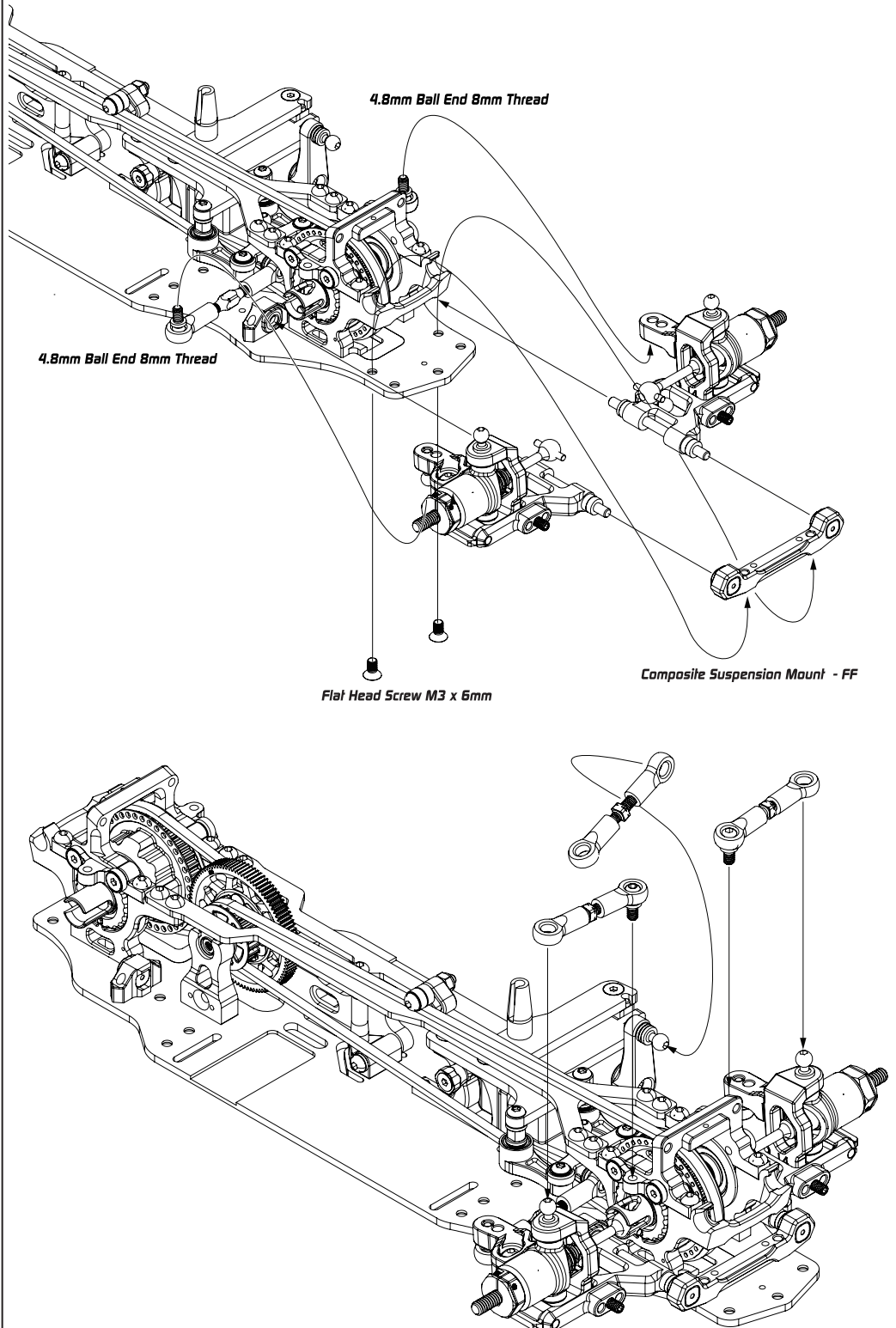

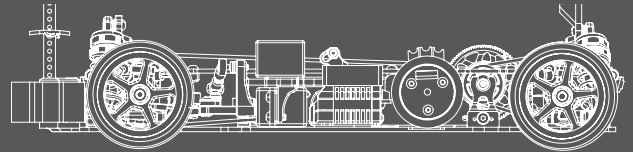

Bag K , Bearing , Screw and Spacer Bag

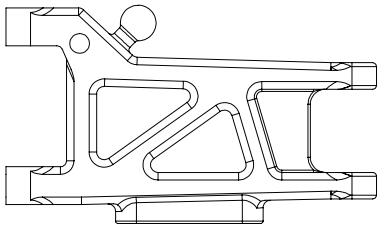

Composite Suspension Arm Rear
XP-10276

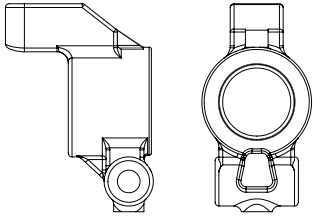

Composite Suspension Rear Upright
XP-10275



Driveshaft Protector Blade
XP-10128



Bearing 5 x 10 x 4mm
XP-40064



Alu Wheel Hub Red
XP-10129



Pin 2 x 9.8mm
XP-40069

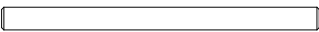

Suspension Pivot Pin 3 x 42mm
XP-10139

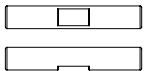

3x18mm C Hub Upright Flat Type Pivot Pin
XP-10337



Hex Set Screw M3 x 8mm
XP-40054

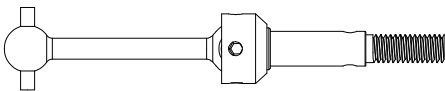

Steel Universal Shaft
XP-10313



Cap Head Screw M1.6 x 4mm
XP-10129



Set Screw M3 x 3mm
XP-40052

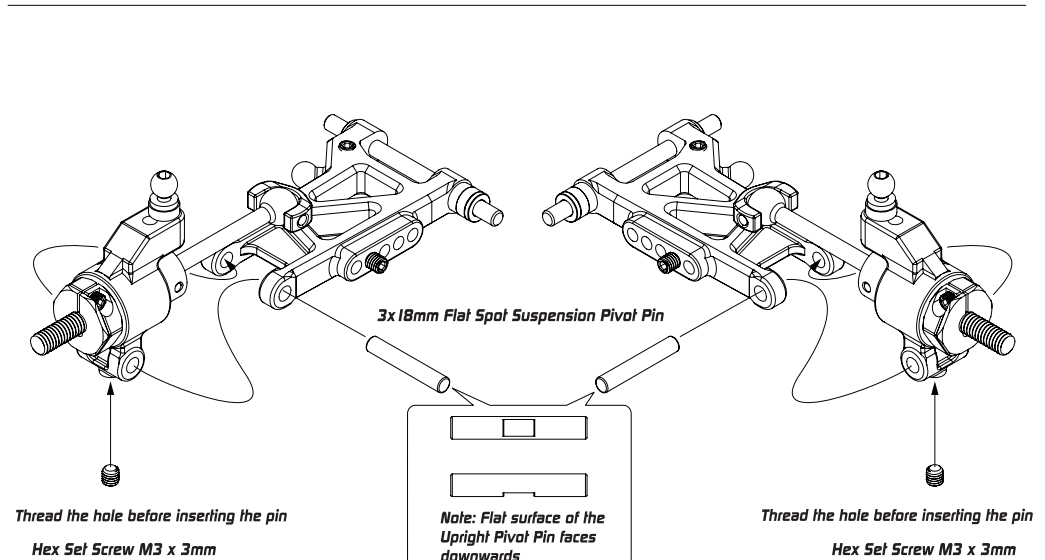
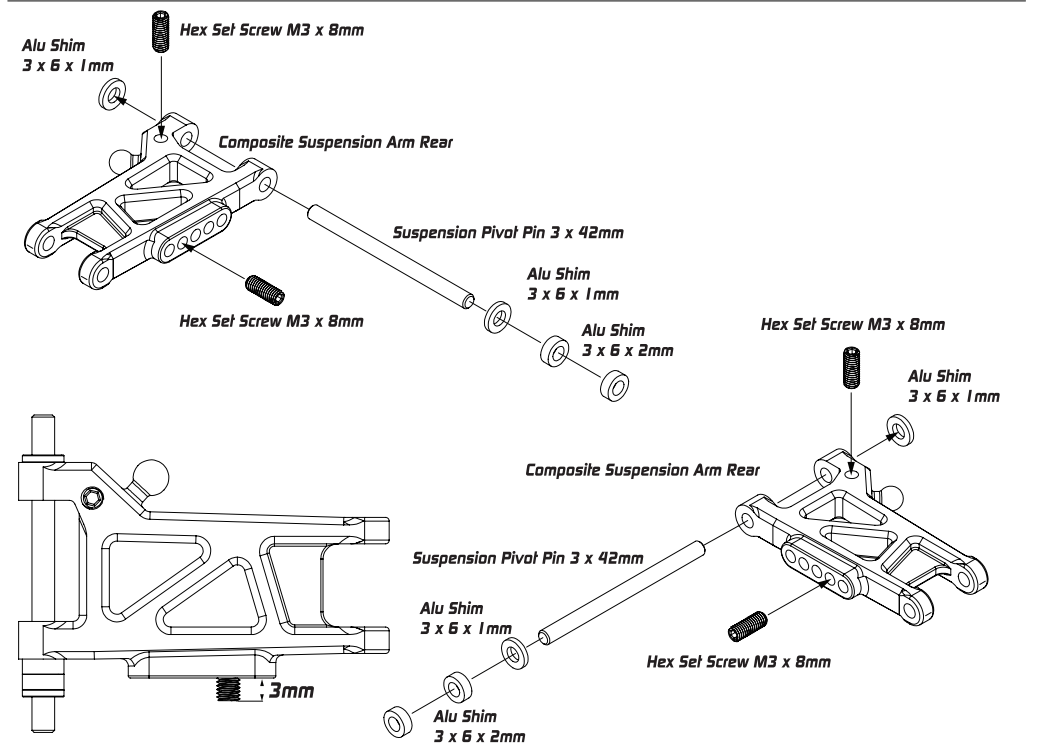
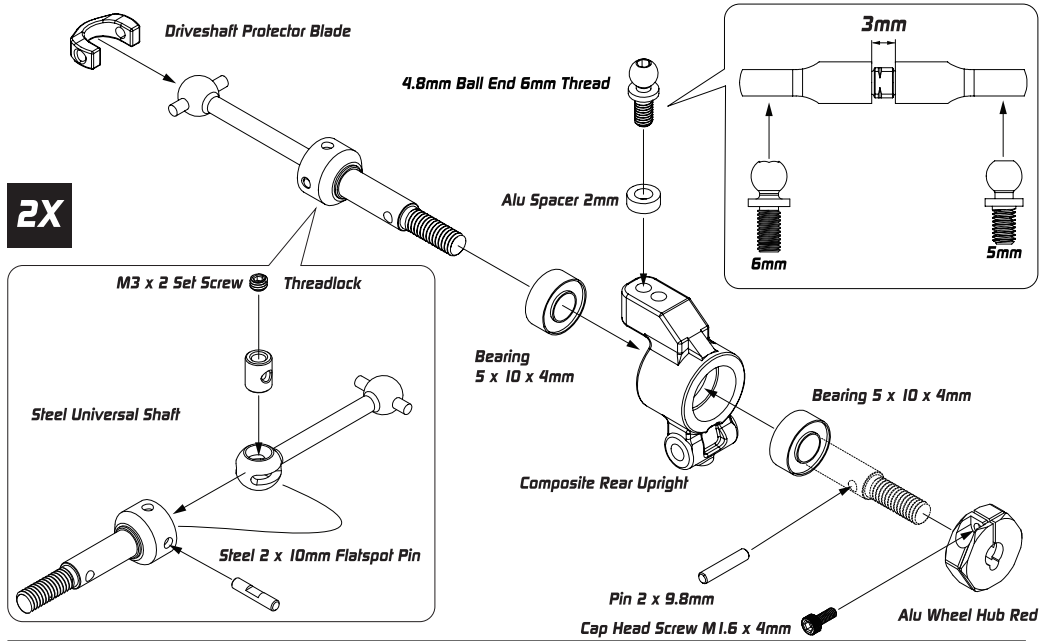

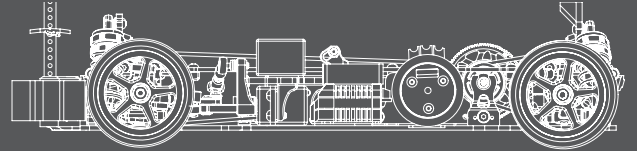

Bag K and Screw Bag

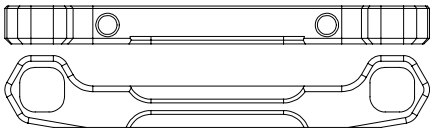

Alu Rear Lower 1-Piece Suspension holder - RR
XP-10124



Flat Head Screw M3 x 6mm
XP-40046

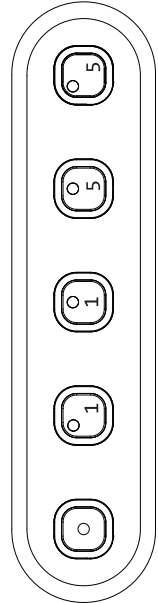

Eccentric Bushing Set
XP-10127

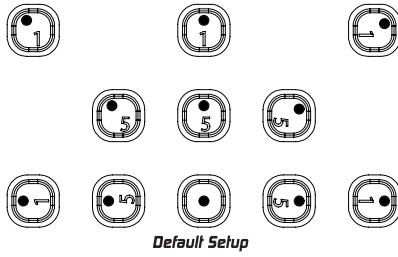

Diagonal Offset
Use either 0.5 or 1 mm to shift the roll center
in a diagonal direction from the center.

Alu Rear Lower 1-Piece
Suspension holder - RR

Eccentric Bushing Set

Horizontal Offset
Choice of either 0.5 or 1 mm offset from center

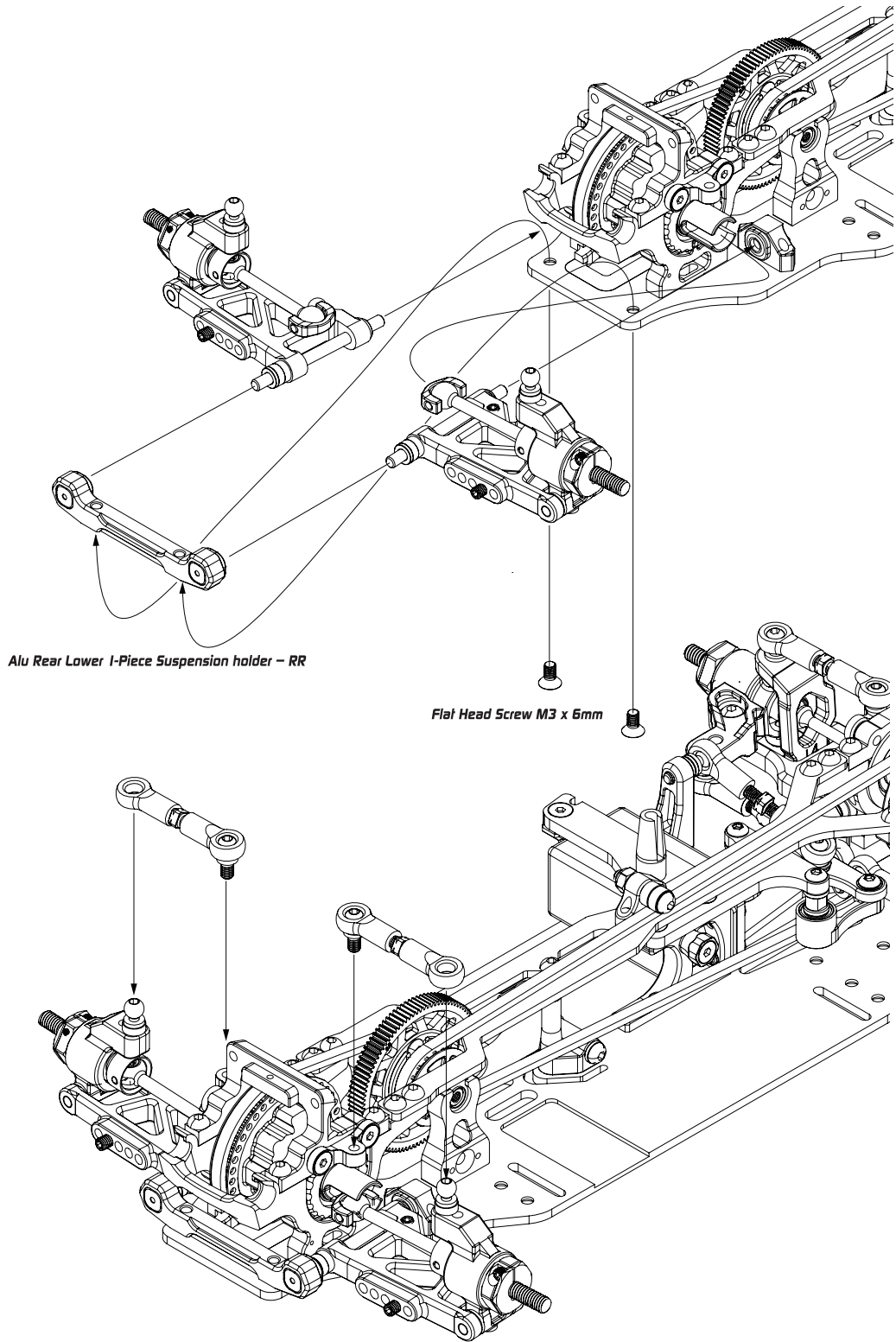

Alu Rear Lower 1-Piece Suspension holder - RR

Flat Head Screw M3 x 6mm

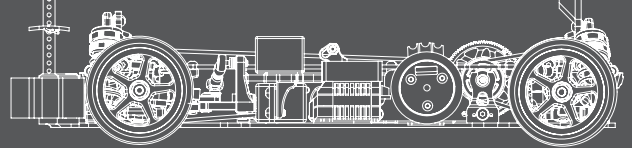

Bag K , Screw and Bearing Bag



Bearing 3 x 6 x 2.5mm
XP-40060



Alu Anti-Roll Bar Bushing
XP-10152



Hex Set Screw
M3 x 2mm
XP-40051

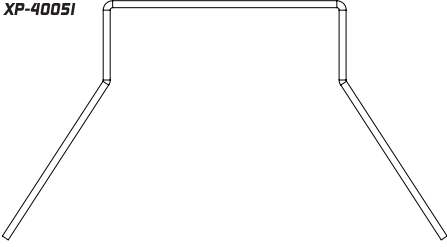

XM15 1.3mm Anti-Roll Bar XP-10314

M3 x 2mm Set Screw

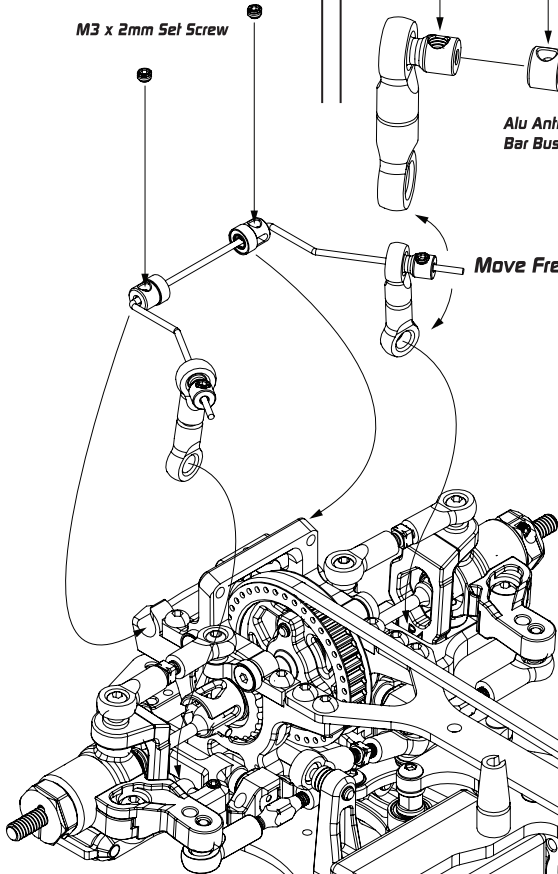

M3 x 2mm Set Screw



Bearing 3 x 6 x 2.5mm

Alu Anti-Roll Bar Bushing

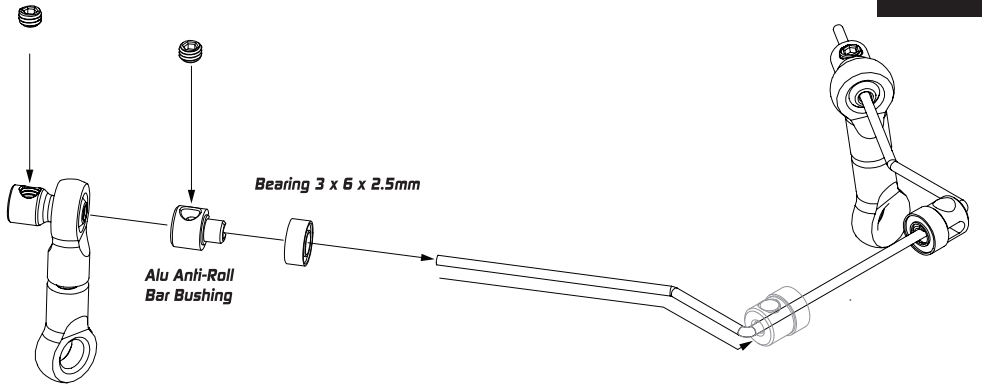

Front

Bearing 3 x 6 x 2.5mm

Alu Anti-Roll Bar Bushing

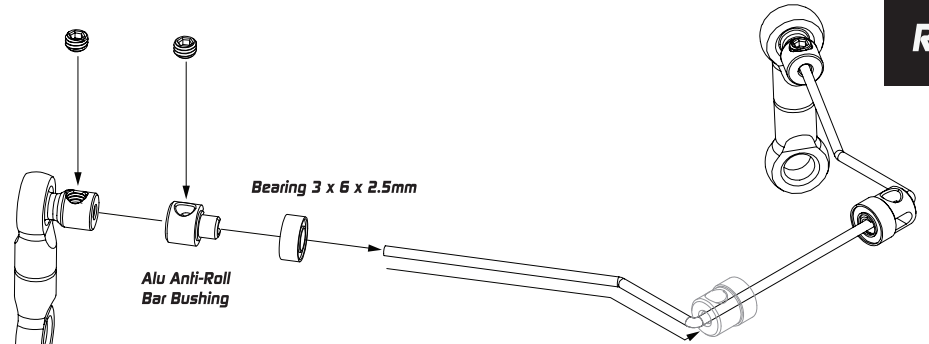

Rear

Move Freely

Move Freely

M3 x 2mm Set Screw

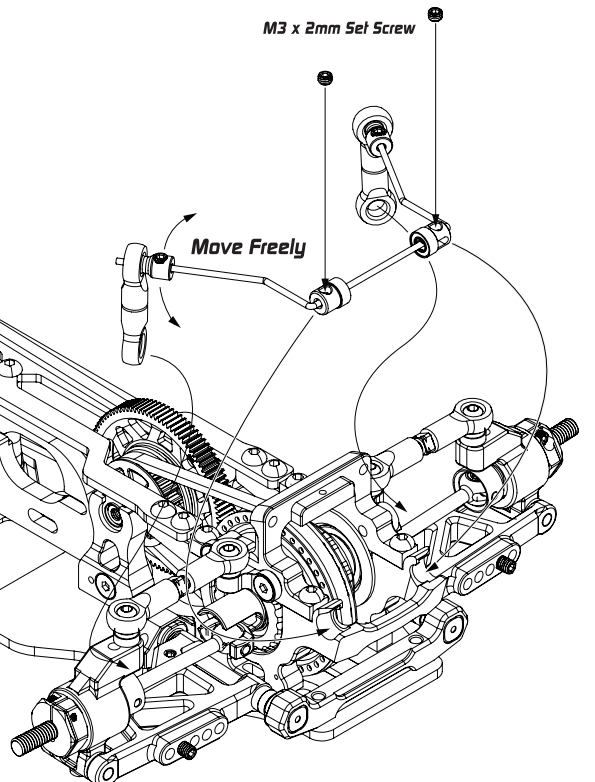

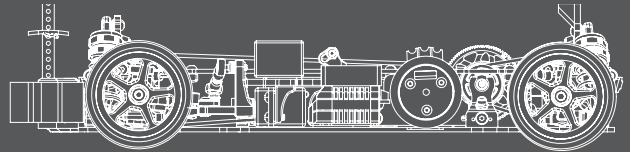

Bag L and Oil Bag

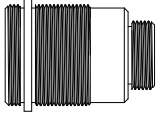

Alu Shock Body
XP-10142

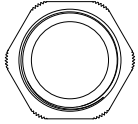

Alu Upper Shock Cap
XP-10146

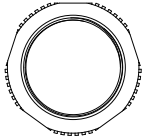

Alu Spring Tension Adjust Nut
XP-10161



Alu Lower Shock Cap
XP-10145

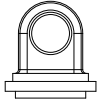

Shock Top Connector v



4 Hole Piston
XP-10159

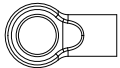

Shock Lower Connector
XP-10144



Shaft Cover
XP-10159



Shaft Spacer
XP-10159



Shock Shaft
XP-10143



Shock Absorber Membrane
XP-10147

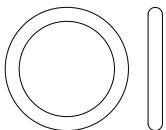

Silicone O Ring For Spring Adjust Nut
XP-10162



Shock O-Ring
XP-10160



E-Clip 2.5mm
XP-40057

Silicone O Ring For Spring Adjust Nut



Alu Spring Tension Adjust Nut

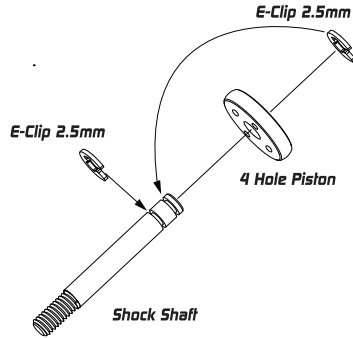

E-Clip 2.5mm

E-Clip 2.5mm

4 Hole Piston

Shock Shaft

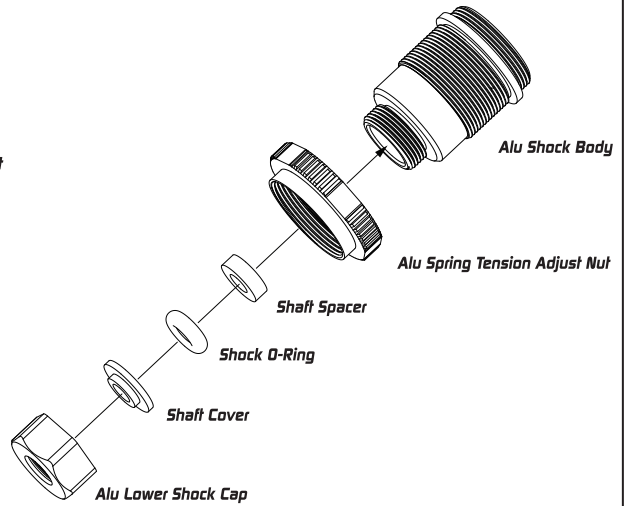

Alu Shock Body

Alu Spring Tension Adjust Nut

Shaft Spacer

Shock O-Ring

Shaft Cover

Alu Lower Shock Cap

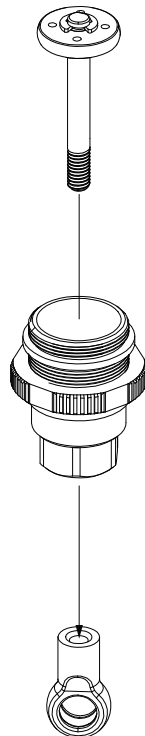

Shock Lower Connector

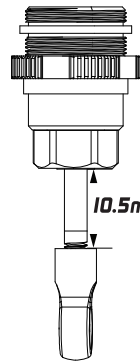
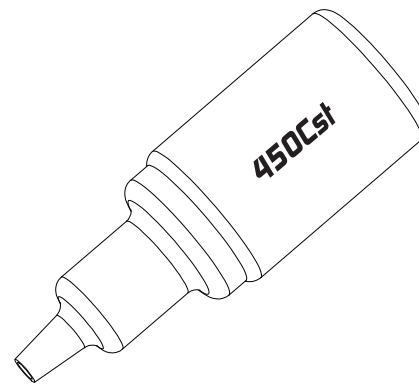

10.5mm

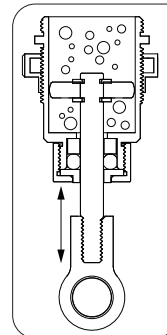

Cycle The Shock Shaft In a Upwards And Downwards Motion To Bring The Air Bubbles Ontop Of The Shock Piston.

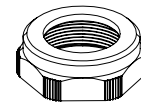

Alu Upper Shock Cap



Shock Top Connector

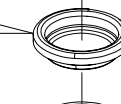

Shock Absorber Membrane

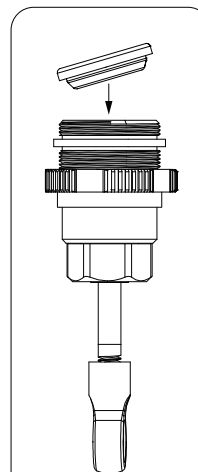

Install the shock bladder slowly on an angle as shown.

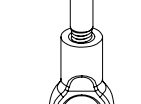
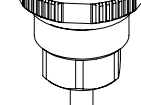
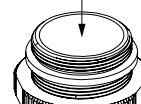

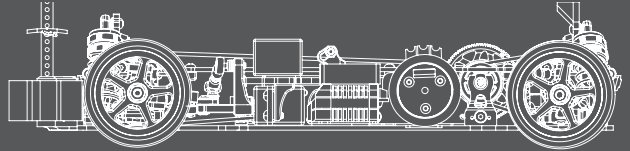

Bag L and Screw Bag

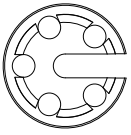

Spring Retainer
XP-10144



Pivot Ball 5.8 mm
XP-10121

Graphite 3.0mm Rear Shock Tower
XP-10357

Default Shock Position

Body Height Adjuster Support

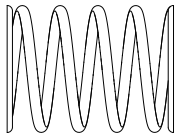

Shock Spring Soft Black
XP-10168

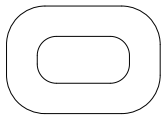

Body Height Adjuster Support
XP-10001

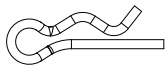

Body Clip
XP-10055



Flat Head Screw M3 x 8mm
XP-40048



Bulton Head Screw M3 x 6mm
XP-40037

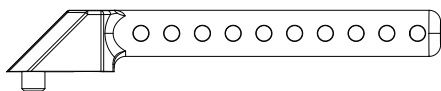

Rear Body Post
XP-10001

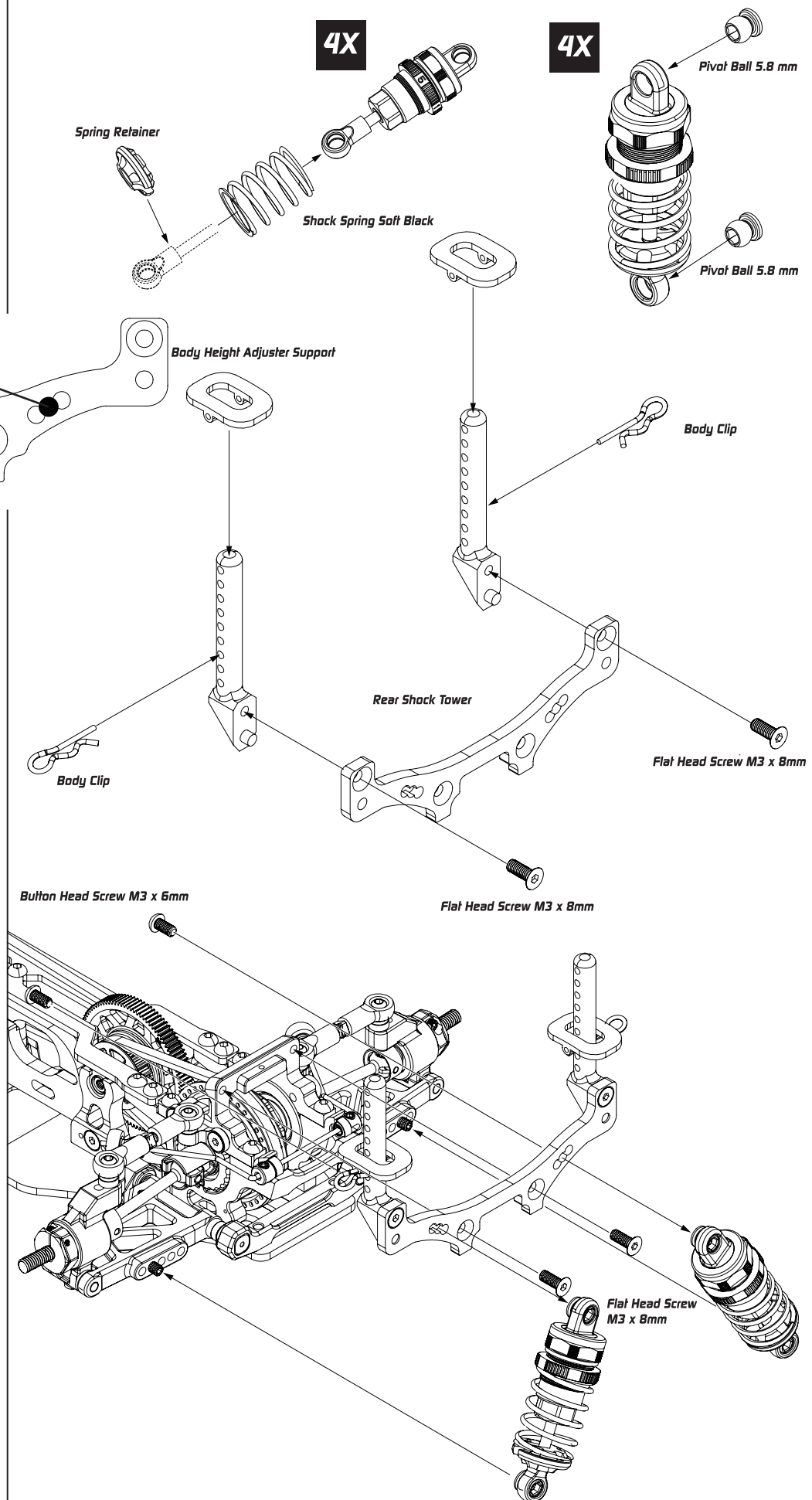

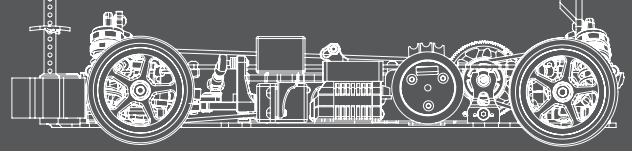

Bag L and Screw Bag

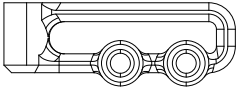

Composite Lipo Battery Backstop
XP-10180



Flat Head Screw M3 x 8mm
XP-40048



Flat Head Screw M3 x 6mm
XP-40046

Default Shock Position

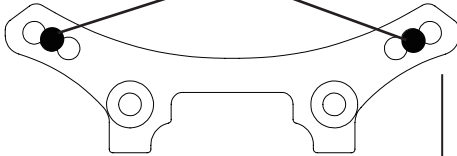

Graphite 3.0mm Front Shock Tower
XP-10356



Bolt Head Screw M3 x 6mm
XP-40037

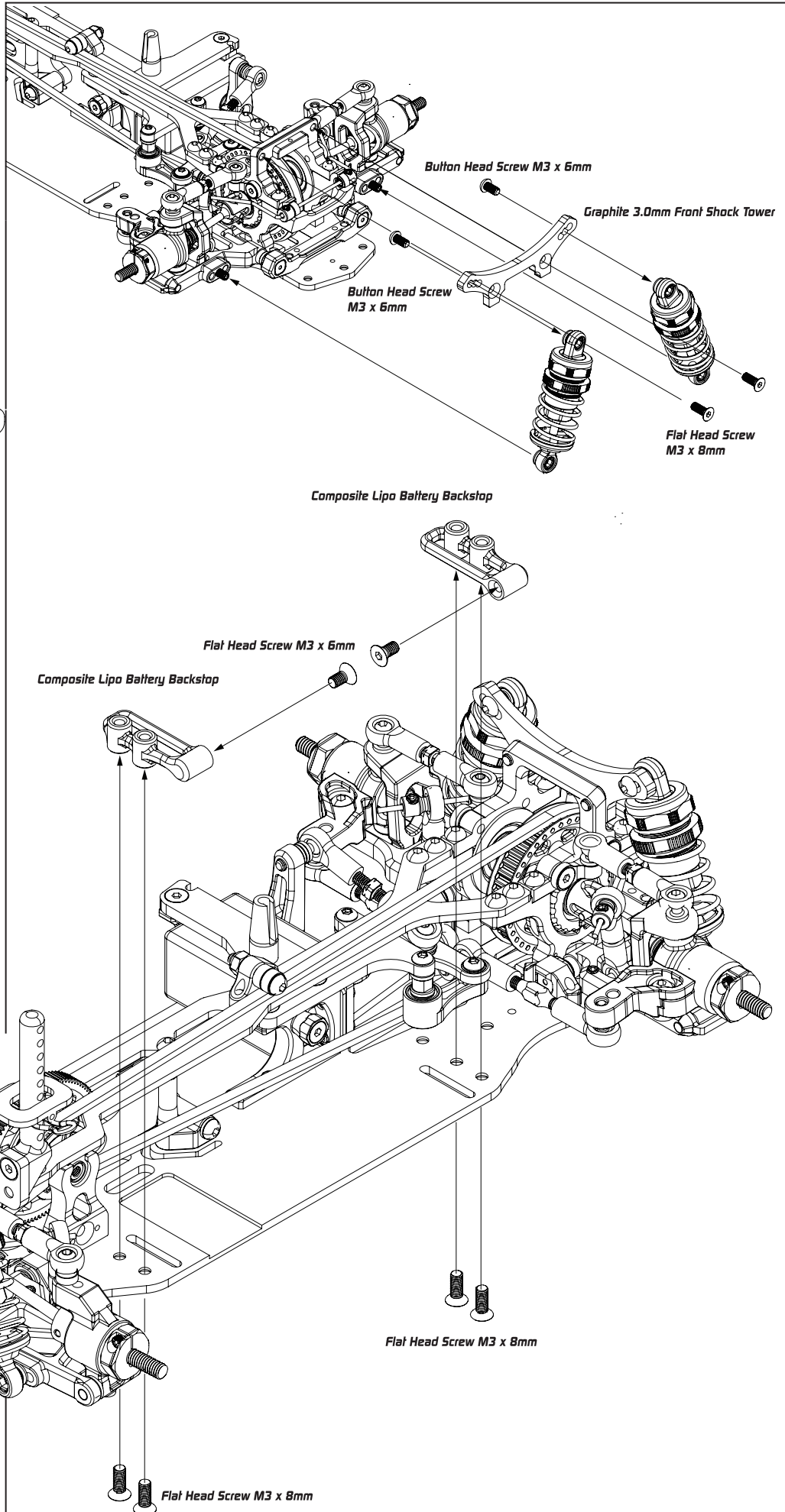

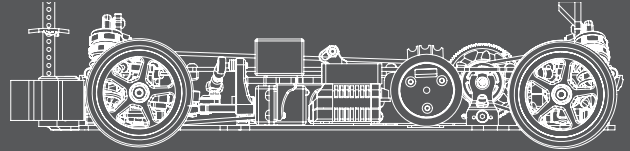

Screw Bag

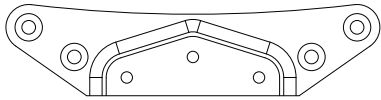

Lower Bumper
XP-10001

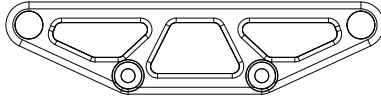

Bumper Plate
XP-10001



Front Body Post
XP-10001

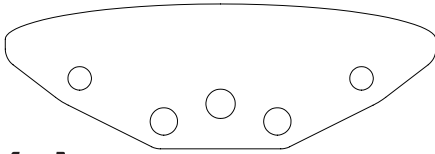

Foam Bumper
XP-10095

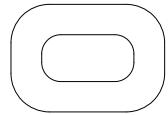

Body Height Adjuster Support
XP-10001

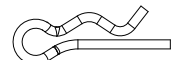

Body Clip
XP-10055



Flat Head Screw M3 x 10mm
XP-40049



Flat Head Screw M3 x 8mm
XP-40048

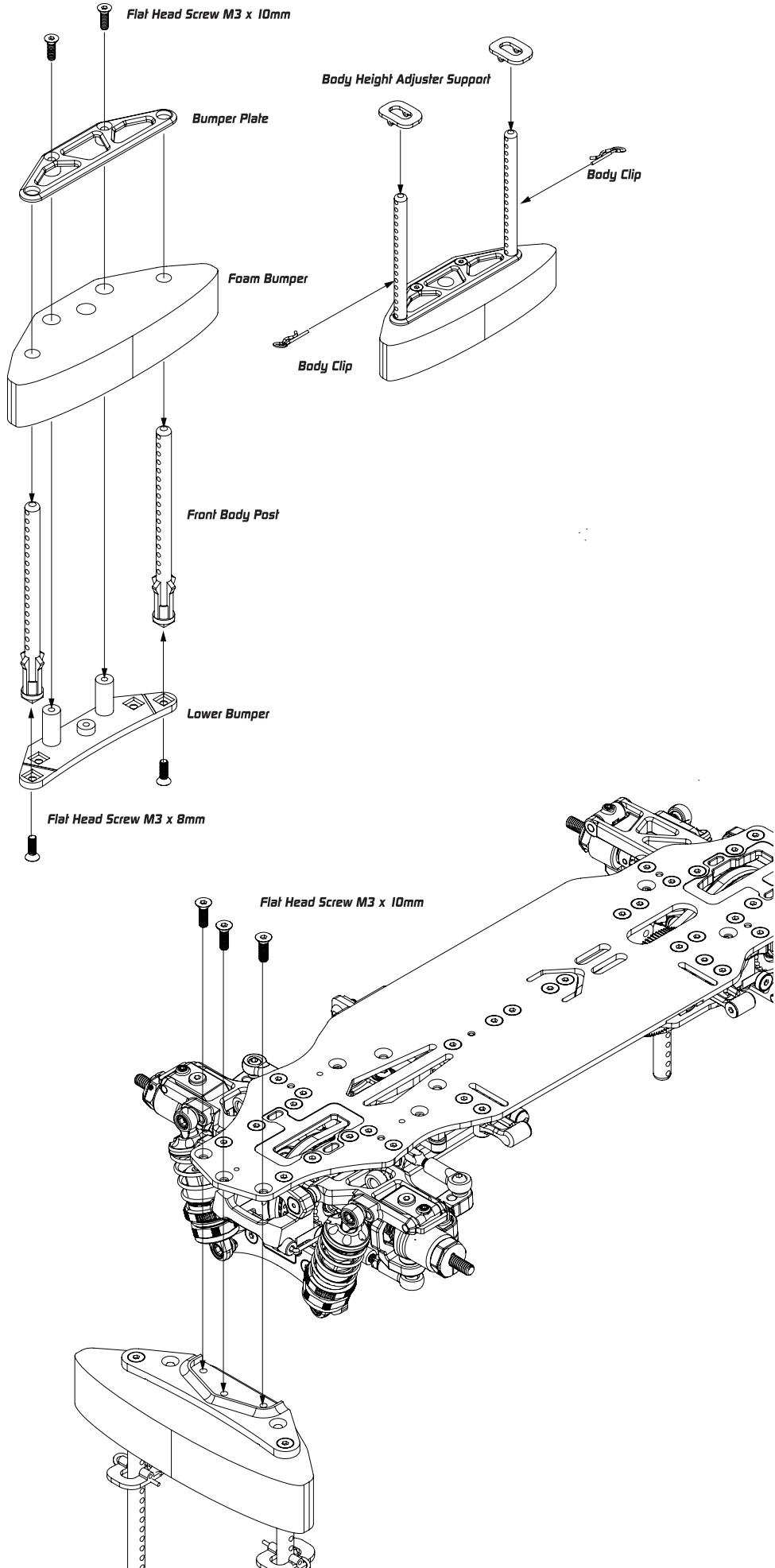

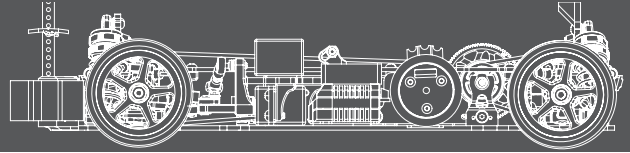

Screw Bag



Lock Nut 7mm
XP-40068

(Motor Not included)

(ESC Not included)

(Receiver Not included)

(Double Side Tap Not included)

Round Head Screw M3 x 8mm

(Pinion Not included)

(Battery Not included)

(Tires Not included)

Lock Nut 7mm

Lock Nut 7mm

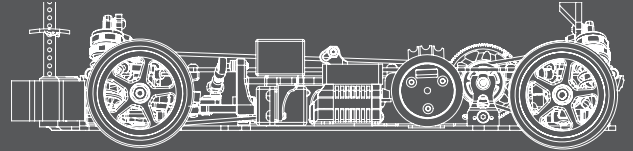

XMI Original Parts	
Model Number	Product Name
XP-10001	Bumper Body Post & Antenna Holder
XP-10002	4.8mm Ball End Set & Ball Bearing Hub
XP-10008	Gear Differential Case and Cover
XP-10011	Gear Differential Repair Parts
XP-10015	Damper Plastic Parts Set
XP-10016	Damper Part Replacement Set
XP-10022	Gear Differential Set
XP-10050	Replacement Shock Shaft Set 4pcs
XP-10051	Replacement Silicone Parts Set
XP-10055	Body Clips 20pcs
XP-10095	Foam Bumper
XP-10107	Composite Ball Bearing Tension Adjustment Hub 4pcs
XP-10119	Aluminium Shim 3x5.5x1.0mm Red 20pcs
XP-10120	Aluminium Shim 3x6x2.0mm Red 20pcs
XP-10123	Aluminium 2 Piece Suspension Mount 2pcs
XP-10124	Aluminium RR Lower one Piece Suspension Mount
XP-10125	Aluminium Gear Diff Outdrive Adapter 2pcs
XP-10126	Steel Spool Outdrive Adapter 2pcs
XP-10128	Driveshaft Protector Blade 8pcs
XP-10129	Aluminium 5mm Wheel Hub Red 2pcs
XP-10131	Rear Camberlink Mount 2pcs
XP-10133	Aluminium Solid Axle
XP-10134	Center Layshaft Pulley Set
XP-10136	Aluminium Servo Mount
XP-10137	3.0mm Graphite Floating Servo Holder
XP-10139	3.0mm Suspension Pivot Pin 4pcs
XP-10148	4.8mm Ball End 5mm Thread 10pcs
XP-10149	4.8mm Ball End 6mm Thread 10pcs
XP-10150	4.8mm Ball End 8mm Thread 10pcs
XP-10151	4.8mm Ball End 10mm Thread 10pcs
XP-10156	Steel Tumbuckle 29 mm 4pcs
XP-10163	Composite Servo Horn Belt Tensioner Set
XP-10164	C Hub King Pin Set 2+2
XP-10175	Aluminium Solid Layshaft
XP-10179	Gear Differential Gasket 5pcs
XP-10181	Gear Differential Spacer 5X15X0.4mm 10pcs
XP-10182	Gear Differential Spacer 3,6X9,5X0.2mm 10pcs
XP-10183	Silicone Gear Differential O-RING 25x1mm 10pcs
XP-10184	Silicone Gear Differential O-RING 5x2mm 10pcs
XP-10229	Composite Lower Bulkhead 2pcs
XP-10230	Front and Rear Composite One Piece Upper Clamp
XP-10231	Composite Layshaft Bulkhead
XP-10232	Aluminum Motor Mount Set
XP-10236	4.8mm Ball End 5mm Thread 4pcs
XP-10237	4.8mm Ball End 6mm Thread 4pcs
XP-10238	4.8mm Ball End 8mm Thread 4pcs
XP-10239	4.8mm Ball End 10mm Thread 4pcs
XP-10251	4.8mm Flat Type Ball End 15MM 4pcs
XP-10252	4.8mm Flat Type Ball End 13MM 2pcs
XP-10253	4.8mm Flat Type Ball End 10MM 4pcs
XP-10254	4.8mm Low Profile Ball End Set
XP-10255	Camber Stiffener Link Ball End
XP-10256	Aluminium Upper Shock Cap 2pcs
XP-10257	Aluminium Lower Shock Cap 2pcs
XP-10258	Aluminium Spring Tension Adjust Nut 2pcs
XP-10259	Aluminum Center Post
XP-10260	Composite Suspension Mount Set
XP-10261	Composite Steering Set

XMI Original Parts	
Model Number	Product Name
XP-10274	Aluminium Layshaft Bulkhead 2pcs
XP-10275	Composite Rear Upright 2pcs
XP-10276	Composite Front and Rear Arm
XP-10277	Composite Steering Block Set
XP-10278	Composite C Hub 4 Degrees
XP-10279	Front Shock Tower
XP-10280	Rear Shock Tower
XP-10281	Anti-Roll Bar Set
XP-10283	Anti-Roll Bar Bushing 2+1
XP-10287	Anti-Tweak Battery Holder
XP-10288	Gear Diff Outdrive Adapter 2pcs
XP-10289	3x18mm C Hub Upright Pivot Pin 4pcs
XP-10313	Steel Universal Shaft 2pcs
XP-10314	Anti-Roll Bar 1.3mm Front and Rear 2pcs
XP-10315	Anti-Roll Bar 1.2mm Front and Rear 2pcs
XP-10316	Anti-Roll Bar 1.4mm Front and Rear 2pcs
XP-10317	Kevlar Drive Belt Front 432mm
XP-10318	Kevlar Drive Belt Rear 171mm
XP-10354	Graphite 2.25mm Bottom Chassis Plate
XP-10355	Graphite 2.0mm High Flex Upper Deck
XP-10356	Graphite 3.0mm Front Shock Tower
XP-10357	Graphite 3.0mm Rear Shock Tower
XP-10362	Lipo & Sub-c Battery Strap (Short)
XP-10363	Touring Spring Ø1.4- BU 1pr
XP-10368	Front Camberlink Mount 2pcs
XP-10369	Rear Camberlink Mount 2pcs
XP-10371	Graphite 2.25mm Bottom Chassis Plate
XP-10372	Graphite 2.0mm Upper Deck
XP-10373	Graphite 3.0mm Front Shock Tower
XP-10374	Graphite 3.0MM Rear Shock Tower
XP-10375	Spring Steel Double Joint Universal Shaft 2pcs
XP-10376	Graphite 3.0mm Front Shock Tower & Body Holder
XP-10263	Floating Servo Holder
XP-10264	Composite Spool 38T Set
XP-10265	Composite Spool Cups 2pcs
XP-10270	Composite Center Pulley 20T 2pcs
XP-10271	FRP 2.5mm Chassis Plate
XP-10272	FRP 2.0mm Top Deck
XP-10262	Composite Wheel Hub Set 4pcs

XMI Option Parts	
Model Number	Product Name
XP-10191	Rf One Piece Suspension Mount
XP-10192	Aluminium Adjustable Battery Stoppers
XP-10193	Aluminium Spring Retainer
XP-10194	FR One Piece Suspension Mount
XP-10196	Brass RF One Piece Suspension Mount
XP-10197	Brass FR One Piece Suspension Mount
XP-10198	Brass 2 Piece Suspension Mount
XP-10199	Brass FF 1 Piece Suspension Mount
XP-10200	Brass RR 1 Piece Suspension Mount
XP-10220	Camberlink Stiffener set
XP-10221	Option Servo Mount Plate (Wire Hide)
XP-10223	Aluminium 3.5mm Ackermann Steering Plate For Dual Servo Saver
XP-10224	Aluminium 5mm Ackermann Steering Plate For Dual Servo Saver
XP-10225	Aluminum Ball Bearing Tension Adjustment Hub 2pcs
XP-10350	Bando Kevlar Drive Belt Rear 3 x 432 mm
XP-10351	Bando Kevlar Drive Belt Rear 3 x 171 mm

Driver _____ Track Surface _____ Track Temperature _____
 Date _____ Track Traction _____ Result _____ Air Temperature _____
 Track _____ Country _____ Best Lap _____ Humidity _____ Remark _____

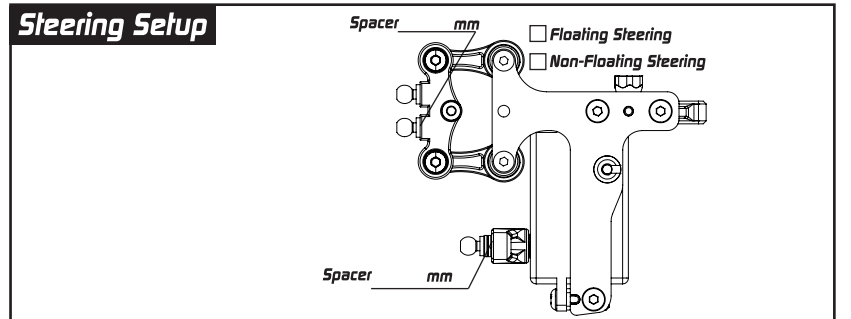
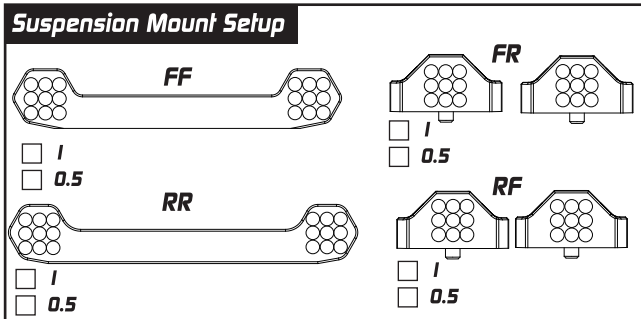
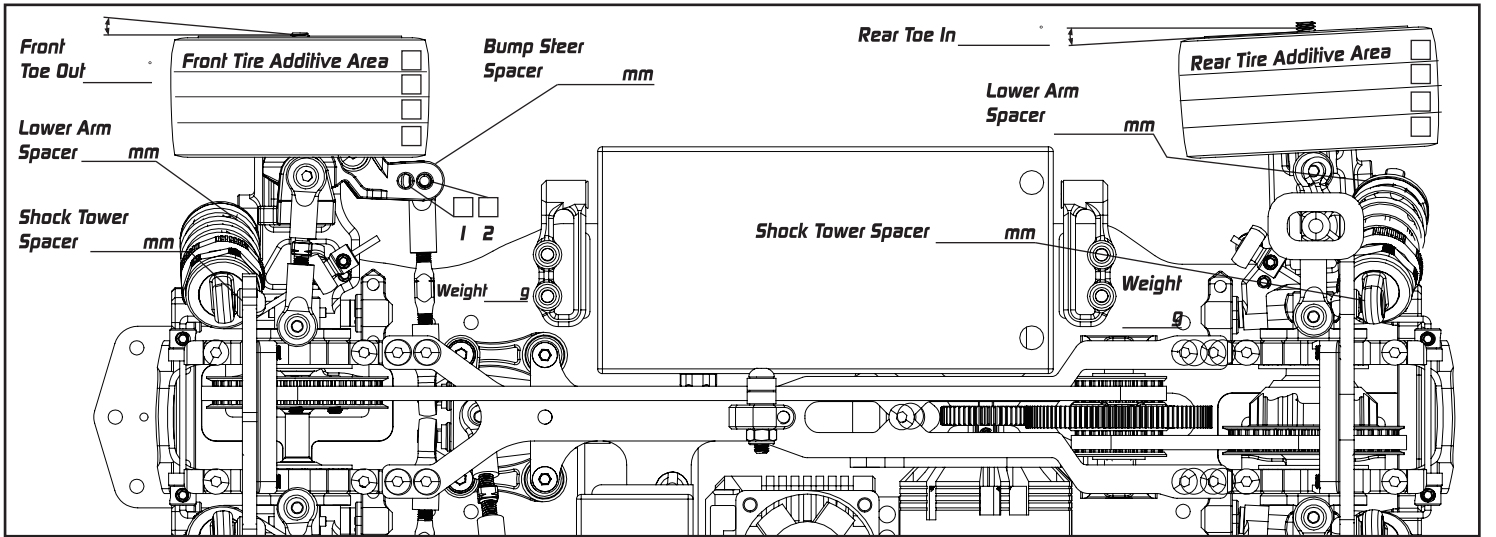
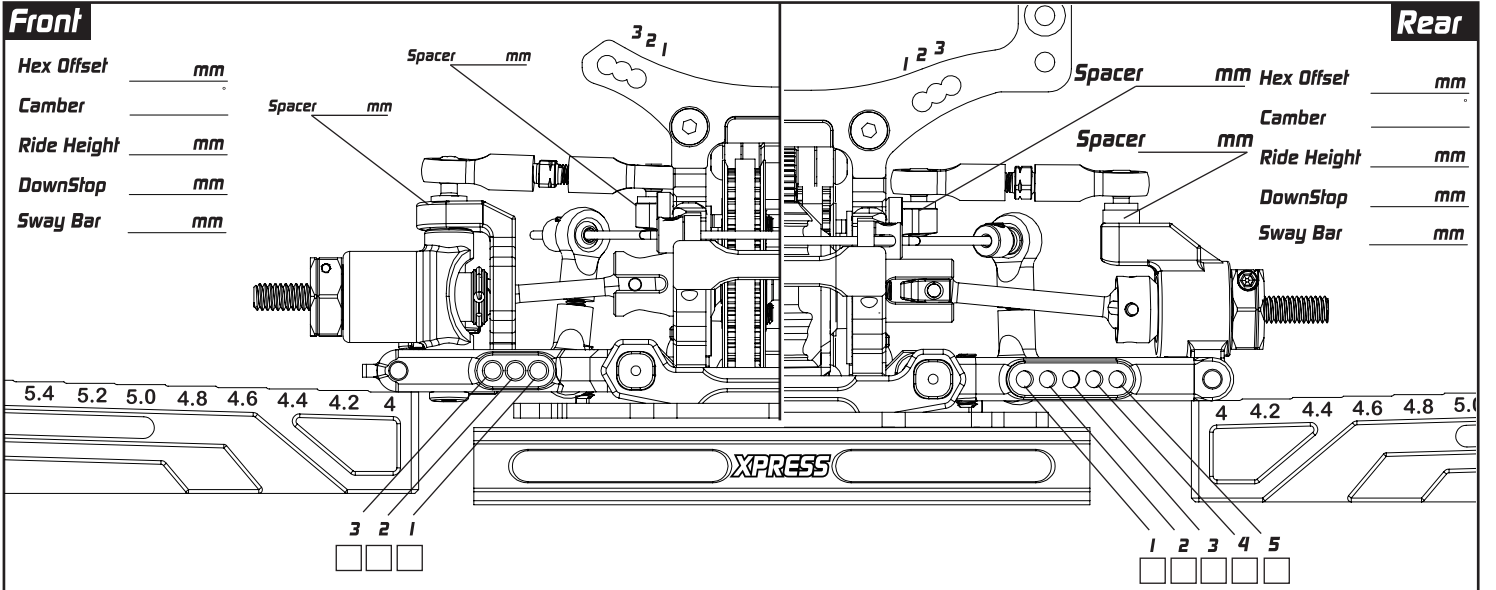

Damper Setup

	Front	Rear
Spring	_____	_____
Oil	_____	_____
Rebound	_____	_____
Piston	_____	_____
Length	_____	_____
Foam Insert	<input type="checkbox"/>	<input type="checkbox"/>
Hole In Cap	<input type="checkbox"/>	<input type="checkbox"/>

Transmission Setup

Front	Rear
Oil _____	Gear Diff _____
Weight _____ g	Oil _____
Position _____	Weight _____ g
	Position _____

Others

Servo _____ Tires _____
 Esc _____ Additive _____
 Motor _____ Body _____
 Spur P/ T Rear Wing _____
 Pinon P/ T FDR _____

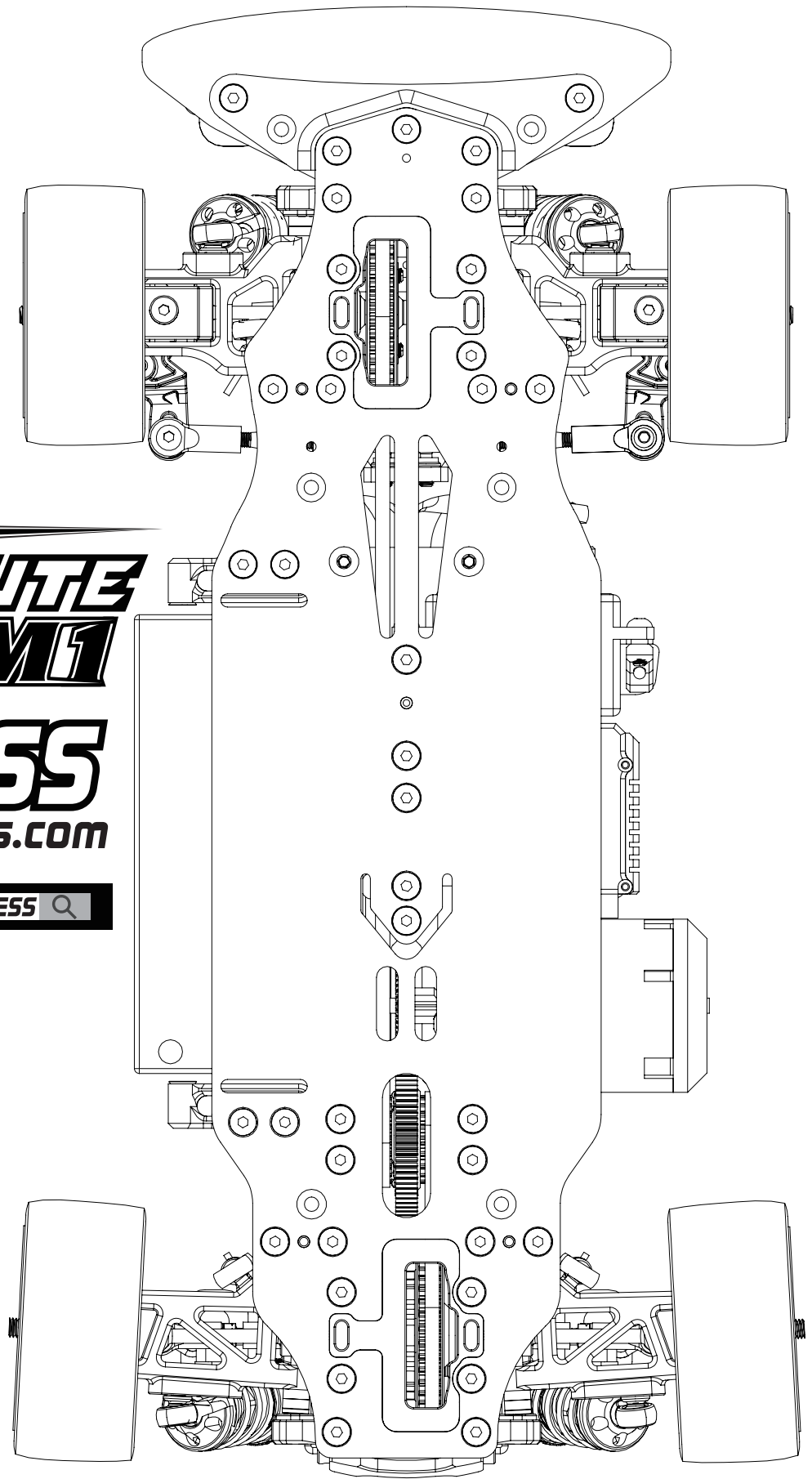

EXECUTE
1/10 4WD MINI COMPETITION TOURING CAR
XM1

XPRESS
www.rc-xpress.com

